



Intelligent Performance



Høj kvalitet og unikke fordele til konkurrencedygtige priser
Quality machinery and exiting features at a competitive prices
Hohe Qualität und einzigartige Vorteile zu konkurrenzfähigen Preisen

- member of the strong SCANTOOL GROUP



Probably the most intelligent and cost-effective metal performance - created by Scantool..!

Scantool A/S leverer en bred vifte af maskiner - alt lige fra den velkendte vådslibemaskine over kantbukkemaskinen til den store værkstedspresse. Scantool kvalitetsmaskiner appellerer til alle - lige fra den kvalitetsbevidste hobbymand - over håndværkeren - til den sorte industri.

Vi bestræber os på altid at levere den rigtige kvalitetsmaskine til den rigtige pris - og vores vision er at det brede program i maskiner alle har ét tilfælde - Vi står inde for kvaliteten og lægger gerne navn til.

Scantool A/S provides a wide range of machines - everything from the well-known wetstone grinding machine and the folding machine to the large workshop press. Scantool quality machines appeal to everyone - from the discerning DIY, to professionals, and large industries.

We strive to always provide the right quality machine at the right price - and our vision is that our wide range of machines all have one thing in common - we guarantee quality and vouch for it with our name.

Scantool A/S bietet eine umfassende Auswahl an Maschinen - vom bewährten Nassschleifer über die Schwenkbiegemaschine bis hin zur großen Werkstatt presse. Die Qualitätsmaschinen von Scantool richten sich an den qualitäts-bewussten Heimwerker ebenso wie an den Profi-Handwerker und die Schwer-industrie.

Unser Ziel ist - die richtige Qualitätsmaschine zum richtigen Preis zu liefern. Unsere Vision - alle Maschinen in unserem Programm haben eines gemeinsam: wir garantieren die Qualität und stehen gern mit unserem Namen für sie ein.

Alle Scantool maskiner er CE godkendte og bærer dette mærke.
Alle Scantool Maschinen sind CE-zertifiziert und tragen dieses Zeichen.
All Scantool machines are CE marked and carry this mark.



SCANTOOL SC 200 DGE A
Med boreslibeaggregat, 4-30 mm
With drill grinding attachment, 4-30 mm
Mit Bohrschleifvorrichtung, 4-30 mm



SCANTOOL SC 150/200 E/T
Dobbeltliber - slibeskiver Ø 150/200 mm
Double ended grinder - grinding wheels Ø 150/200 mm
Doppelschleifer - Schleifscheiben Ø 150/200 mm



SCANTOOL SC 200 POT
Polermaskine med polerskærme, spindler og polerskiver
Polishing machine with polishing guards, spindles and polishing mops
Poliermaschine mit Polierschutzhauben, Spindeln und Polierscheiben



SCANTOOL SC 150/200 ES/TS
Dobbeltliber med slibeskive og stålborste
Double ended grinder with grinding wheel and wire brush
Doppelschleifer mit Schleifscheibe und Drahtbürste



SCANSLIB 150
Vådsliber - slibeskive 152 x 40 x 20 mm
Wet stone grinder/sharpener - Wheel size 152 x 40 x 20 mm
Nassschleifer - Polierscheibe 152 x 40 x 20 mm

SCANSLIB 200 / 200 S
Vådsliber - slibeskive 200 x 45 x 20 mm
Wet stone grinder/sharpener - Wheel size 200 x 45 x 20 mm
Nassschleifer - Polierscheibe 200 x 45 x 20 mm



SCANTOOL 250
Bænksliber på søjle med sug
- slibeskiver 250 x 32 x 20 mm
Grinder on pedestal with exhaust
- grinding wheels 250 x 32 x 20 mm
Schleifer auf Ständer mit Absaugung
- Schleifscheiben 250 x 25 x 32 mm



SCANTOOL SC 200 EKB/TKB
Speciel knivsliber med bånd og filtskive
Special knife grinder with belt and felt disc
Spezial Messerschleifer mit Band und Pflilzscheibe



SCANTOOL TBG 618
Dobbeltliber - slibeskiver Ø 150 mm med indbygget lys
Double ended grinder - grinding wheels Ø 150 mm - with built-in light
Doppelschleifer - Schleifscheiben Ø 150 mm - mit eingebaut Licht



SCANTOOL SC 150/200 E/T
Slibemaskine på søjle med separat nødstop
Pedestal grinder with separate emergency stop
Doppelschleifer auf Ständer mit separat Notstopp

SCANTOOL 75V / 150V
 Vertikal/horisonalt båndsliber
 Vertikal/horisonalt Belt grinder
 Vertikal/horisonalt Bandschleifmaschine

SCANTOOL 75VX / 150VX
 Indbygget udsugning
 Built-in exhaust system
 Integrierte Absaugung

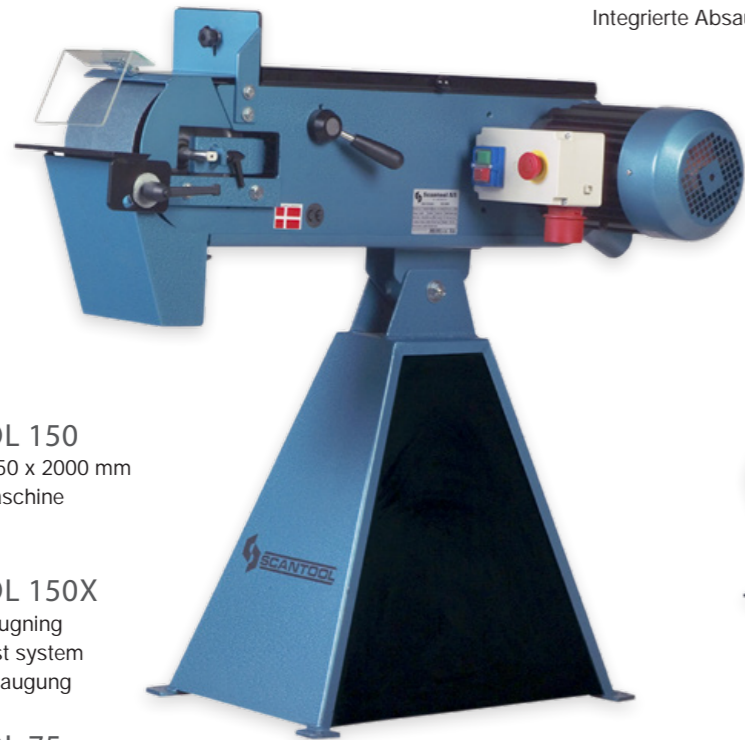

SCANTOOL 150
 Båndsliber - 150 x 2000 mm
 Bandschleifmaschine
 Belt grinder

SCANTOOL 150X
 Indbygget udsugning
 Built-in exhaust system
 Integrierte Absaugung

SCANTOOL 75
 Båndsliber - 75 x 2000 mm
 Belt grinder
 Bandschleifmaschine

SCANTOOL 75X
 Indbygget udsugning
 Built-in exhaust system
 Integrierte Absaugung



5 års motorgaranti
 5 years motor warranty
 5 Jahre Motorgarantie



SCANTOOL 75X SILVERSTAR
 Båndsliber til aluminium med udsugning
 Belt grinder for aluminium with exhaust system
 Bandschleifmaschine für Aluminium mit Absaugung



SCANTOOL 75FG / 150FG
 Mobil gulvsliber - 75/150 x 2000 mm
 Mobile floor belt grinder
 Mobile Boden-Bandschleifer



Stort slibebplan / Large surface table / Großer Planschleiftisch



Optional: Støvsamler / Dust collector / Staubfänger. See page 8



Nem båndregulering / Easy belt travel adjustment / Leichte Bandlauf regulierung



Båndskifte uden brug af værktøj / Belt change without tools / Bandwechsel ohne Werkzeug

SCANTOOL 1220
 Bordmodel - 100 x 1220 mm
 Bench type - 100 x 1220 mm
 Tisch Modell - 100 x 1220 mm



SCANTOOL 1600
 Med fast slibearm - 50 x 1600 mm
 With fixed belt arm - 50 x 1600 mm
 Mit festem Schleifarm - 50 x 1600 mm

SCANTOOL 1600 X
 Indbygget udsugning
 Built-in exhaust system
 Integrierte Absaugung





Combined in automation process with 6 stations



5 års motorgaranti
5 years motor warranty
5 Jahre Motorgarantie



SCANTOOL 75 / 150 RB/RBX

Rørsliber med og uden sug for rør og profilrør, Ø 17 - 100 mm

Pipe notcher with or without exhaust for tubes and sections, Ø 17 - 100 mm

Rohrausschleifer mit oder ohne Absaugung für Rohre und Profile, Ø 17 - 100 mm



Built-in exhaust system



Built-in exhaust system

SCANTOOL 150 CGW

Centerless slibemaskine med 2 stationer og køling
Centerless grinding machine with 2 stations and cooling
Centerless Schleifmaschine mit 2 Stationen und Kühlung

SCANTOOL 75 CG/CGX

Slibning og polering af rør, Ø 20 - 100 mm
Grinding and polishing of tubes, Ø 20 - 100 mm
Schleifen und Polieren von Rohren, Ø 20 - 100 mm



SCANTOOL 250 AGM/AGS

Afgratemaskine med eller uden udsugning
Deburring machine with or without exhaust system
Entgratungsmaschine mit oder ohne Absaugung



SCANTOOL 75 CGC - New Model
Slibning og polering af rør, Ø 10 - 100 mm, med køling
Grinding and polishing of tubes, Ø 10 - 100 mm, with cooling
Schleifen und Polieren von Rohren, Ø 10 - 100 mm, mit Kühlung
2-speed motor

SCANTOOL 100 / 150 RS/RSX

Kompakt all-in-one rørslibemaskine, Ø 21 - 100 mm
Compact all-in-one pipe grinding machine, Ø 21 - 100 mm
Kompakte Rohrausschleifmaschine, Ø 21 - 100 mm

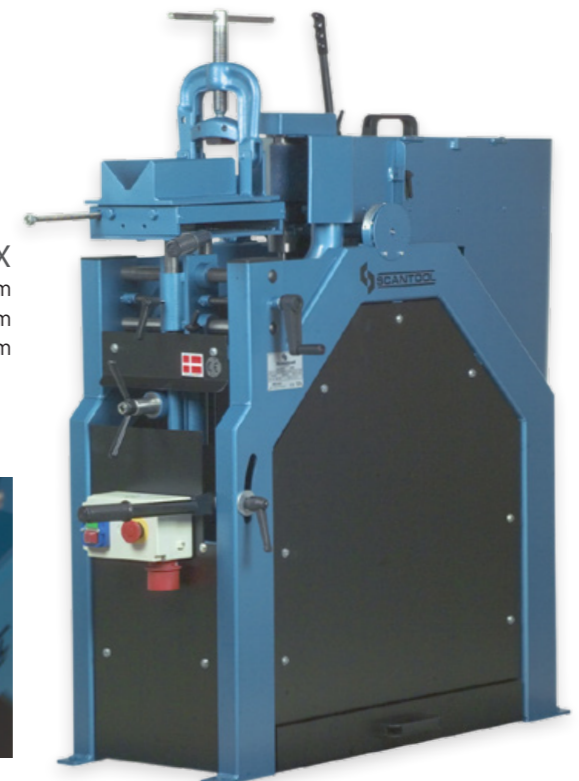

Centerless Grinding

Pipe Machinery



SCANTOOL Cyklon 100 S
 Komplet støvopsamler og filterenhed
 Complete dust collector and filter unit
 Komplette Staubfänger und Filtereinheit



SCANTOOL Cyklon 100 SX
 Komplet udsugnings- og filterenhed
 Complete dust extraction and filter unit
 Komplette Absaugungs- und Filtereinheit



SCANTOOL RS Serie
 Væggrørsuger / Wall exhaust system / Wandrauchabsauger
 2000 mm / 3000 mm / 4000 mm



SCANTOOL MB & COMPACT Serie
 Magnetboremaskiner - MB-35 / MB-45 / Compact 36 / Compact 50
 Magnetic drilling machines - MB-35 / MB-45 / Compact 36 / Compact 50
 Magnetbohrmaschinen - MB-35 / MB-45 / Compact 36 / Compact 50



SCANTOOL 13A / 16AE-ATF / 25A
 Remtrukne søjleboremaskiner
 V-belt driven drill presses
 Säulenbohrmaschinen mit Keilriemen



SCANTOOL SB 30/40
 Geardrevne søjleboremaskiner, MK3/MK4
 Geared head drilling machines, MT3/MT4
 Getriebe-Bohrmaschinen, MK3/MK4

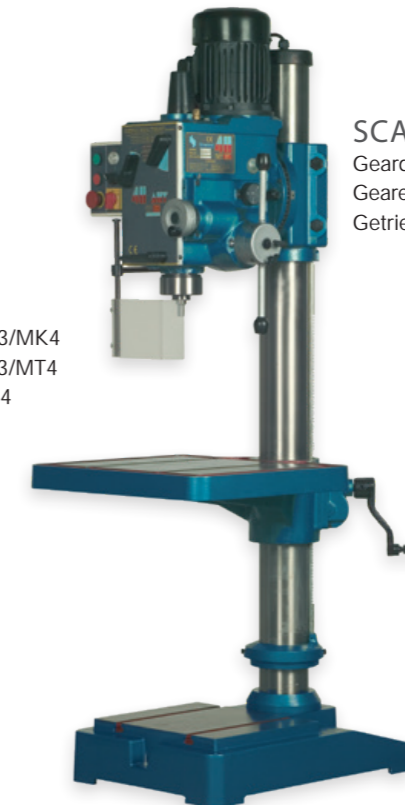

SCANTOOL SC 40/45
 Geardrevne bore- & fræsemaskiner, MK3/MK4
 Geared head milling- & drilling machines, MT3/MT4
 Getriebe-Bohr- & Fräsmaschinen, MK3/MK4

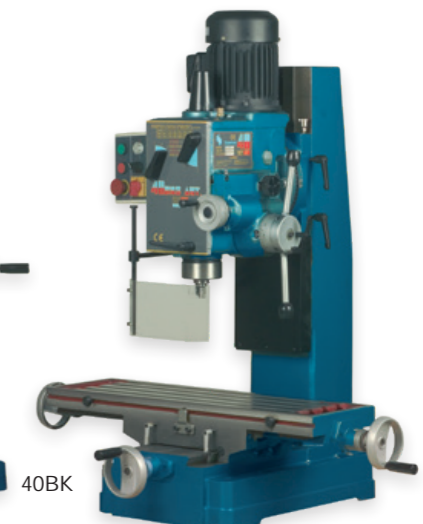

40BK



Polishing spindles



Grinding belts and discs



Core drills/cutters, 12-60 mm



Drill grinding attachment, 4-30 mm + 30-60 mm



Contact & drive wheels

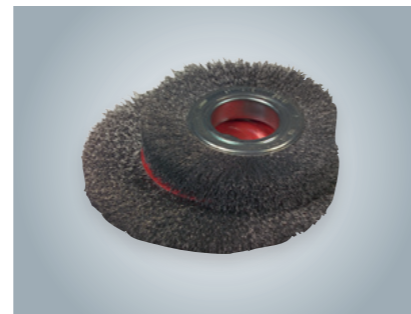

Wire brushes, Ø125-300 mm



Grinding wheels, Ø125-300 mm

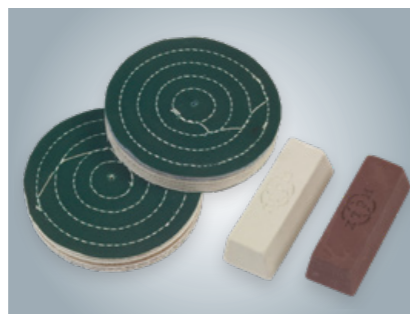

Polishing mops & wax

Stort program i originalt Scantool tilbehør og reservedele

Wide program in original Scantool accessories and spare parts

Groß Programme in original Scantool Zubehör und Ersatzteile

SCANTOOL 125 V
Transportable Model
 Semi automatisk båndsave til metal, 0 - 60°
 Semi automatic band saws for metal, 0 - 60°
 Semi automatische Bandsäge für Metall, 0 - 60°



SCANTOOL 220/280 GSHE/GSHT
 Båndsave til metal med hydraulisk cylinder, 0 - 60°
 Band saws for metal with Hydraulic cylinder, 0 - 60°
 Bandsäge für Metall mit Hydraulischem Zylinder, 0 - 60°



SCANTOOL 320 GSHT Semi Auto
with "One Touch" auto operation
 Båndsave til metal med manuelt skruestik, 0 - 60°
 Band saws for metal with manual vise, 0 - 60°
 Bandsäge für Metall mit Hydraulischem Schraubstock, 0 - 60°

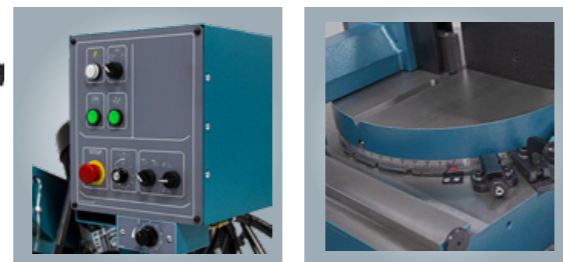
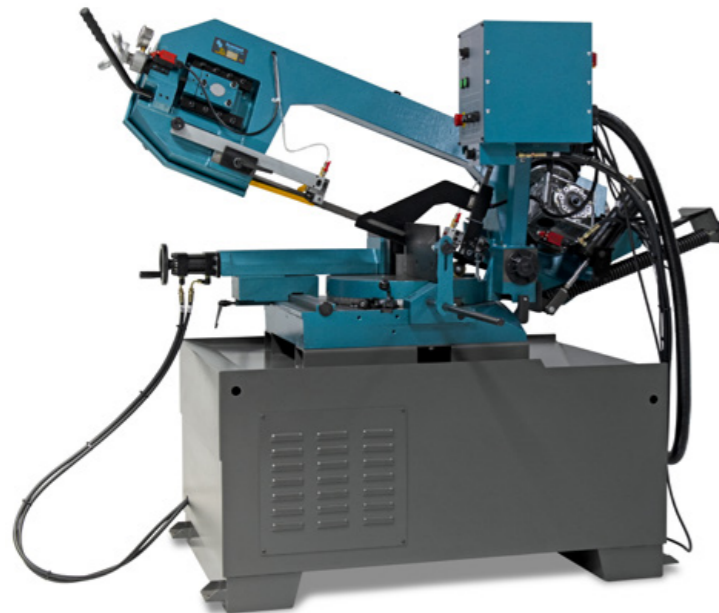

SCANTOOL 420 GSHT Semi Auto
with "One Touch" auto operation
 Båndsave til metal med hydraulisk skruestik, 0 - 60°
 Band saws for metal with Hydraulic vise, 0 - 60°
 Bandsäge für Metall mit manuellem Schraubstock, 0 - 60°

SCANTOOL PV 30
 Profilvervalse til bukning af profiler og rør
 Profile Bending Machine for profiles and pipes
 Profilwalzen zum Biegen von Profilen und Rohren



SCANTOOL PV 35
 Profilvervalse til bukning af profiler og rør
 Profile Bending Machine for profiles and pipes
 Profilwalzen zum Biegen von Profilen und Rohren



SCANTOOL PV 60
 Hydraulisk profilvalsetil bukning af profiler og rør
 Hydraulic Profile Bending Machine for profiles and pipes
 Hydraulische Profilwalze zum Biegen von Profilen und Rohren



SCANTOOL PT -2
 Hydrauliske rørbukkemaskine inkl. bukkelodser 3/8" - 2"
 Hydraulic pipe bending machine with bending formers 3/8" - 2"
 Hydraulische Rohrbiegemaschine mit Biegeforme 3/8" - 2"

Band Saws

Pipe & Profile Bending



SCANTOOL 1250 / 2000
 Eergonomisk design med special-udkast både front og bag
 Ergonomic design with special front & rear cut-piece dispenser
 Ergonomisches Design mit Speziell Auswurf vorne und hinten
 Working length 1270 - 2000 mm - Capacity 3,0-4,0 mm
 Patented RTO system (Return To Operator)



SCANTOOL TSM - Manual
 Pladesakse 650 x 1,25 mm - bord model
 Sheet shears 650 x 1,25 mm Bench type
 Blechscheren 650 x 1,25 mm Tisch Modell



SCANTOOL TSP 150 - Pneumatic
 Pladesakse 1030 - 2020 mm / 1,25-2,0 mm
 Sheet shears 1030 - 2020 mm / 1,25-2,0 mm
 Blechscheren 1030 - 2020 mm / 1,25-2,0 mm



SCANTOOL TSM - Manual
 Pladesakse 1050 - 1330 mm / 1,25 mm
 Sheet shears 1050 - 1330 mm / 1,25 mm
 Blechscheren 1050 - 1330 mm / 1,25 mm

SCANTOOL TSX - Manual
 Pladesakse / slagsakse 1020 x 1,5 mm
 Sheet shears / hand lever shears 1020 x 1,5 mm
 Blechscheren / Schlagscheren 1020 x 1,5 mm



WSP 20/50 Pneumatic
 Værkstedspresere, håndbetjente, 20 - 50 ton
 Workshop Presses, hand operated, 20 - 50 ton
 Werkstattpressen, handbediente, 20 - 50 ton

WSP 100/150 Motorised
 Værkstedspresere, håndbetjente, 100 - 150 ton
 Workshop Presses, hand operated, 100 - 150 ton
 Werkstattpressen, handbediente, 100 - 150 ton



SCANTOOL WSP 15F
 Værkstedspresere, fod- og håndbetjente - 15 ton
 Workshop Presses, foot- and handoperated - 15 ton
 Werkstattpressen, fuss- und handbediente - 15 ton



SCANTOOL WPT 100/160
 Værkstedspresere med manuel/motoriseret bevægelig portal
 Portal presses with manual/motorised movable portal
 Portalpressen mit manuell/motoriseret bewegliches Portal

SCANTOOL SCST Serie - Manual w/segments

Håndbetjente bukkemaskiner 660 - 1300 mm / 1,2-2,0 mm
 Hand operated folding machines 660 - 1300 mm / 1,2-2,0 mm
 Handbediente Schwenkbiegemaschinen 660 - 1300 mm / 1,2-2,0 mm



Scantool SCA serie
with sharp nose blade

Scantool SCB serie
with high upperbeam



SCANTOOL SCAN 10S / 13S FLEX

Hånd- og fodbetjente bukkemaskiner med segmentopdelt over-,
 under- og bukkevange, 1020 - 1270 mm / 1,5 - 2,0mm

Hand and foot-operated folding machines with segment divided clamp,
 bed and fold bars, 1020 - 1270 mm / 1,5- 2,0 mm

Hand- und fussbediente Schwenkbiegemaschinen mit Segmenten in
 Ober-,Unter- und Biegewange, 1020 - 1270 mm / 1,5 - 2,0 mm



SCANTOOL SCAN 10/13S

Hånd- og fodbetjente bukkemaskiner
 1020 - 1270 mm / 2,75 mm

Hand and foot-operated folding machines
 1020 - 1270 mm / 2,75 mm

Hand- und fussbediente Schwenkbiegemaschinen
 1020 - 1270 mm / 2,75 mm



SCANTOOL EBR - Serie

Motoriserede og hydrauliske pladevalser,
 650 - 3050 mm / 1,5-12,0 mm

Motorised and dydraulich bending rollers,
 650 - 3050 mm / 1,5-12,0 mm

Motorisierte und hydraulische
 Rundbiegemaschinen,
 650 - 3050 mm / 1,5-12,0 mm

SCANTOOL MBR - CONICAL Serie

Håndbetjente pladevalser med konisk buk
 Hand operated bending rollers with conical bending
 Handbediente Rundbiegemaschinen mit Konischbiegeeinrichtung

1050 - 2050 mm / 1,5-3,0 mm

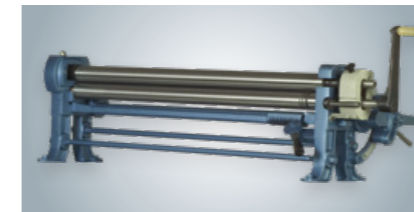

Bench model without conical bending



SCANTOOL MBR - Serie

Håndbetjente pladevalser, 500 - 2050 mm / 0,8-2,0 mm

Hand operated bending rollers, 500 - 2050 mm / 0,8-2,0 mm

Handbediente Rundbiegemaschinen, 500 - 2050 mm / 0,8-2,0 mm



SCANTOOL EBR - CONICAL Serie

Motoriserede pladevalser, 1250 - 2050 mm / 1,0-3,0 mm

Motorised bending rollers, 1250 - 2050 mm / 1,0-3,0 mm

Motorisierte Rundbiegemaschinen, 1250 - 2050 mm / 1,0-3,0 mm

Folding Machinery

Bending Rollers



SCANTOOL A/S er et selvstændigt selskab under Scantool Group, som består af fem velkonsoliderede selskaber og fire stærke brands: SCANTOOL, KEF-MOTOR, HM MACHINERY og ARBOGA.

For yderligere information om det store produktprogram se vores online katalog på www.scantool-group.dk eller scan QR koden.

SCANTOOL A/S is an independent company within the Scantool Group which consists of 5 well consolidated companies and 4 strong brands: SCANTOOL, KEF-MOTOR, HM MACHINERY and ARBOGA.

For further information about the wide product program please see our online catalogue on www.scantool-group.com or scan the QR code.

SCANTOOL A/S ist eine selbstständige Firma unter Scantool Group. Die Gruppe besteht aus 5 gutlaufende Firmen und 4 starke Marken: SCANTOOL, KEF-MOTOR, HM MACHINERY und ARBOGA.

Weitere Informationen sehen Sie entweder im Onlinekatalog auf www.scantool-group.de oder wenn Sie den QR-Kode einscannen.



We look forward to your visit on scantool-group.com, just scan the QR code



SCANTOOL A/S
Industrivej 3-9
DK-9460 Brovst, Denmark
Tel: +45 98 23 60 88
Fax: +45 98 23 61 44
info@scantool-group.dk

Sale & distribution:



www.scantool-group.com