

2018

BUILDPRO[®]

● ● ● ● ● Welding Tables



FABRICATE COST EFFECTIVELY
WITH MODULAR FIXTURING

StrongHandTools[®]

800.989.5244
StrongHandTools.com



Place a BuildPro® Table in your shop, and you will discover how modular fixturing will benefit your operation in greater productivity and improved work quality. Enjoy fast setup replication and reduced project lead times in prototyping, short production runs, or dedicated volume production runs.



Ready to purchase your BuildPro® Table? Find your local Authorized Distributor at:
www.BuildProTables.com



Watch Modular Fixturing How-To Videos at:
www.YouTube.com/StrongHandTools



BuildPro Fabricators - Show off what you've built! Post an image of your fixture or weldment [#FixturePicture](#).



Educational Discounts - Ask about our Modular Fixturing for Education Table + Fixturing Kit packages.



QUICK ACTING WELDING TOOLS
www.stronghandtools.com



HEAVY DUTY GERMAN MADE WELDING TABLES
www.siegmundtables.com



OPERATING ACCESSORIES & TOOLING COMPONENTS
www.valtrainc.com



TOGGLE CLAMPS & LATCHES
www.goodhandinc.com

USA Headquarters

8750 Pioneer Blvd.,
Santa Fe Springs, CA 90670, U.S.A.

Tel: 562-949-8625

Fax: 562-949-4875

sales@stronghandtools.com

Europe

Pražská 410/11
67401 Třebíč, Czech Republic

Tel: +420 607 088 466

Fax: +420 568 853 213

sales@stronghand.eu

Asia

No. 605 Huabo Rd, Huating Town,
Jiading District, Shanghai, China 201816

Tel: +86-21-59103639

Fax: +86-21-59102951

asiasales@stronghandtools.com



<p>TABLES 09 - 17</p>							
<p>TABLE ACCESSORIES 18 - 27</p>							
<p>CLAMPS & PLIERS 27 - 33</p>							
<p>SQUARES / STOPS 33 - 35</p>							
<p>FLANGE PLATE 36</p>							
<p>RESTS & STOPS 37 - 43</p>							
<p>FASTENERS 43 - 45</p>							
<p>TOOL CART 46</p>							
<p>FIXTURING KITS 48 - 51</p>							
<p>FIXTURING EXAMPLES 52 - 57</p>							

** All product, product specifications and data are subject to change without notice to improve reliability, function, design or otherwise. Please check online for updated information and details.*

SET-UP FIXTURES FOR EACH UNIQUE JOB

IMPROVE PRODUCTIVITY AND WORK QUALITY

REDUCE PRODUCTION COSTS, LEAD TIMES & SCRAP



Precision ground steel plates, with CNC machined $\text{Ø}5/8$ " holes in a 2" grid pattern for locating, positioning and mounting BuildPro® clamps and accessories.

Plates can be reconfigured to expand the width of the table for larger projects.

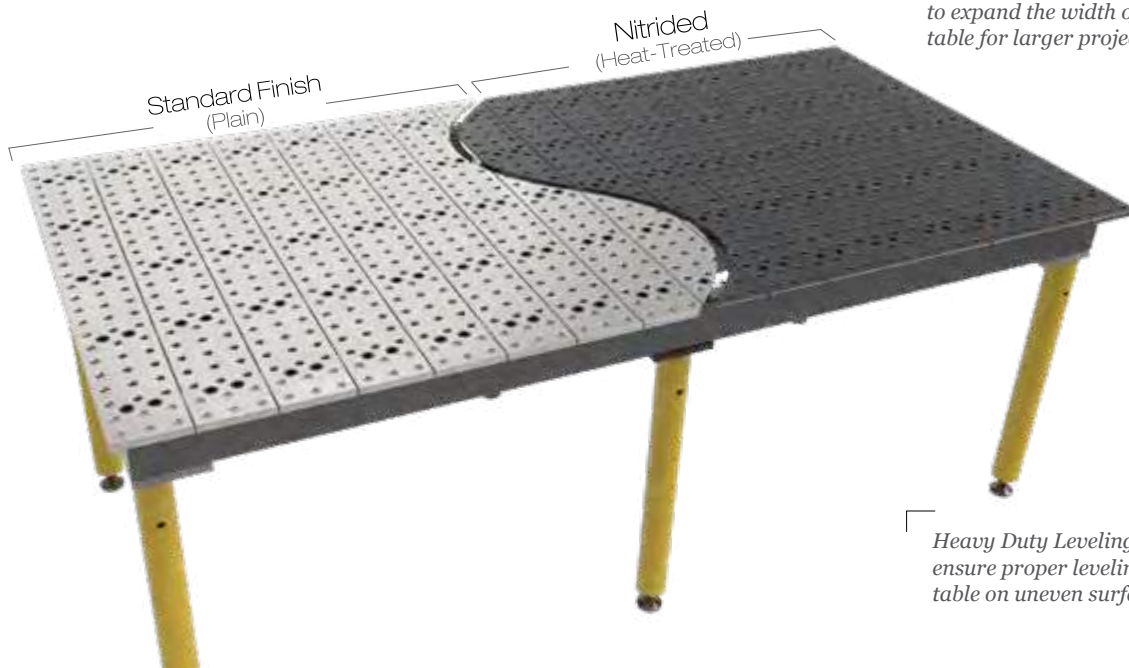

Heavy Duty Leveling Feet ensure proper leveling of the table on uneven surfaces.

BuildPro® Table Accuracy

- Table flatness: 0.012" / 3 feet
- Hole diameter: 0.625^{±0.002}
- Hole spacing: 2.000" ±0.0015
- Plate thickness: 0.630" ±0.004

Standard (plain) finish - Medium Carbon Steel

Nitrided (Heat-Treated) Tabletop

The BuildPro® is available with a protective nitrided tabletop. The nitriding (heat-treating) process is a mechanical polish and post salt bath oxidative treatment. The benefits of this process include weld spatter resistance and corrosion and wear resistance.

- Surface hardness: HV 550
- Nitriding case depth: 0.0004" - 0.0008"
- Coefficient of friction: 0.37

2x LIFE

NEW REVERSIBLE SELF-LOCATING TABLE PLATES!

Get longer wear from your BuildPro® Table.

When the surface of your BuildPro® Table plates show signs of wear, turn them over to provide a new work surface.

New, Patented Bushing design allows you to remove, re-position, re-align, and reverse the table plates!

Mounting Screws & Locating Bushings may also be purchased separately. See pg. 27.

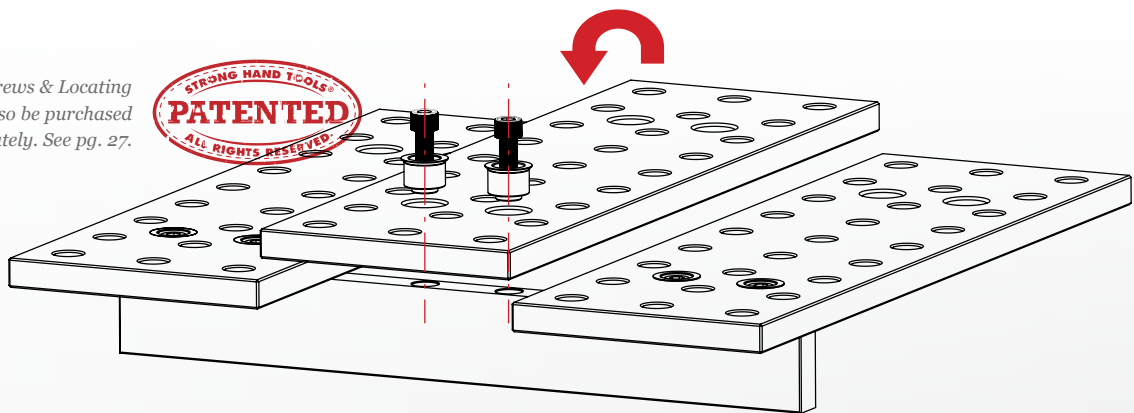

**Your new reversible BuildPro®
Table plates are self-locating.**

EVERY YEAR WE EXPAND THE BUILDPRO TABLE LINE TO MEET CUSTOMER DEMAND. IT IS IMPORTANT TO HAVE A WELDING SURFACE **THAT WORKS BEST FOR YOU** TO MAXIMIZE COMFORT, SAFETY, AND PRODUCTIVITY.

CHOOSE YOUR TABLE SIZE & FINISH

See page 10~17

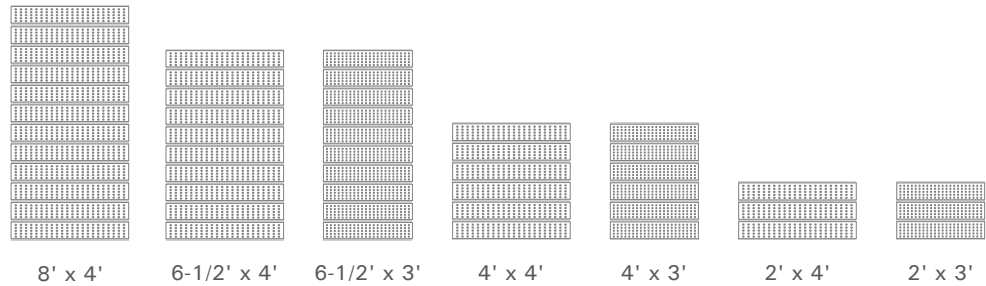

CHOOSE YOUR TABLE LEGS

See page 19



2-1/4" Dia.
Standard Legs



3" Dia.
Heavy Duty Legs



3" Dia.
Adjustable Legs

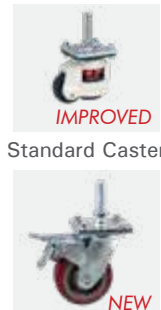

IMPROVED
Standard Caster



NEW
Mobility Caster

OR CHOOSE A PLATFORM

See page 20~22



Rotary Positioner



Scissor Lift Platform



Ergonomic Lift Platform

All BuildPro® Tables are constructed from 5/8" thick steel plate, with Ø5/8" CNC machined and holes chamfered in a 2" grid pattern. All tables, except the BuildPro® MAX series, have 1.7" slots between plates.

- All load capacities are calculated based on evenly distributed static load.
- Optional Leg Braces and Casters. See page 18 & 19.

HOW TO CALCULATE "TABLE SURFACE HEIGHT"

Example: Part No. *TMQRC59648F* (pg.10)

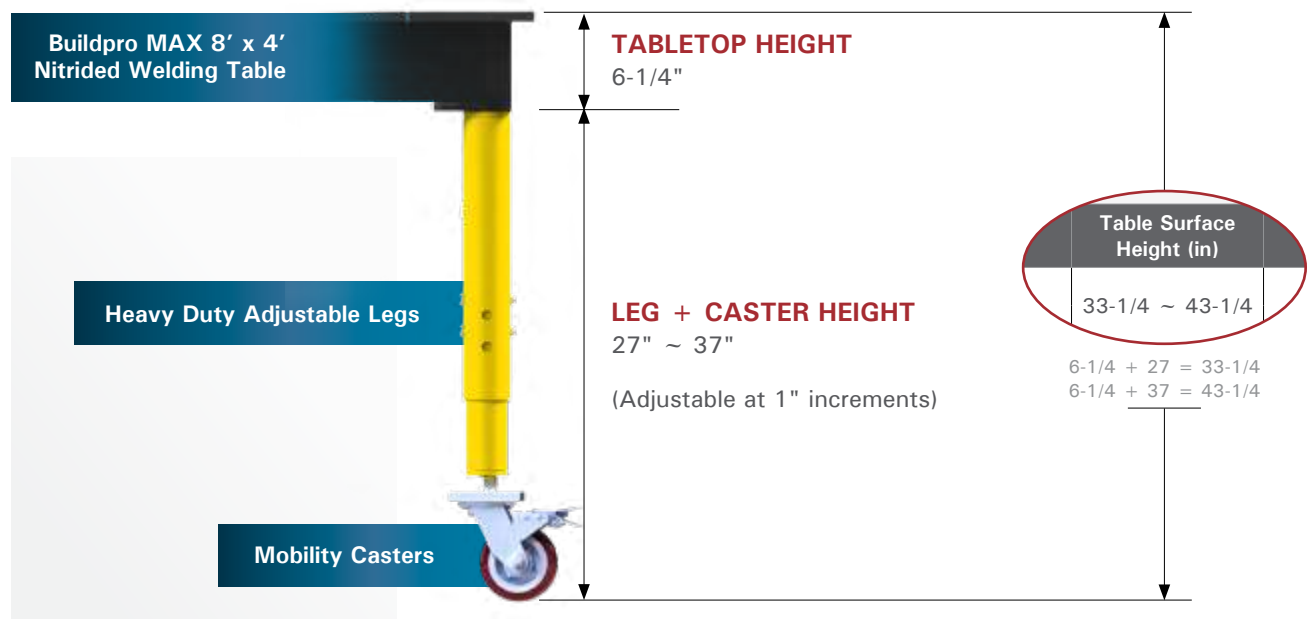

Example: Part No. *TMA57846* (pg.13)

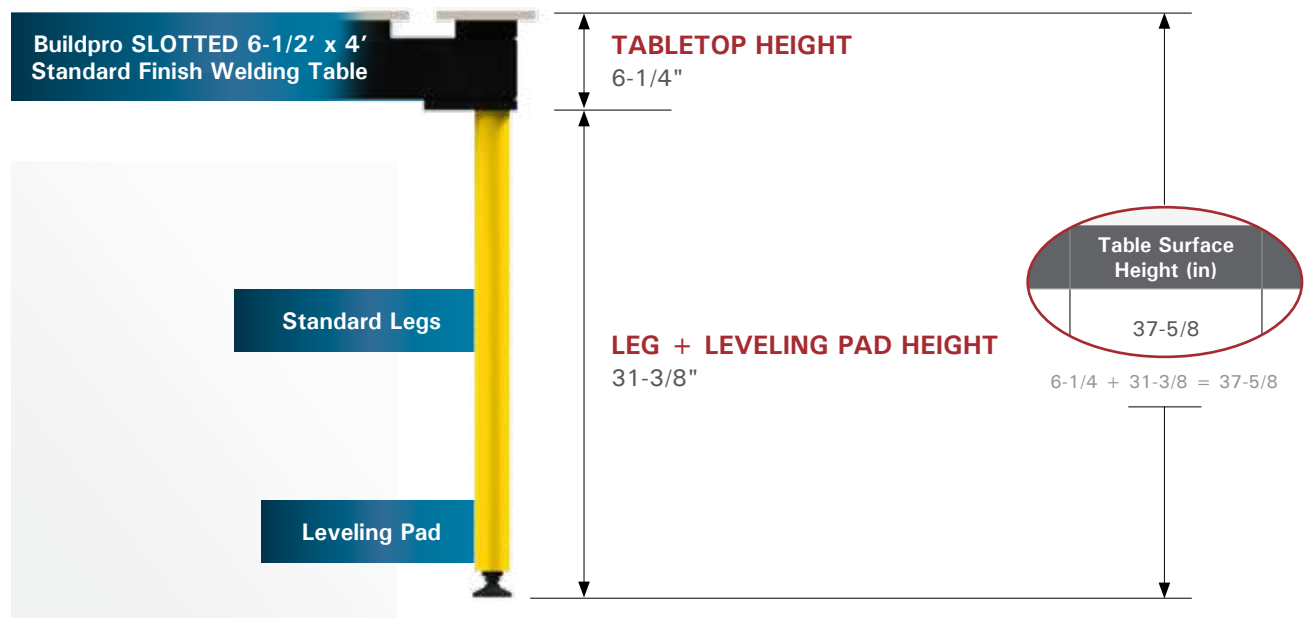

* For Stationary Scissor Lift Platforms & HD Ergonomic Height-Adjustable Lift Platforms, ADD the 6-1/4" BuildPro® Tabletop height to the heights shown for each platform model.

KEY ELEMENTS in the BuildPro® Modular Fixturing System

NEW DESIGN



*** Ball Lock Bolt**
- An essential component in Modular Fixturing!

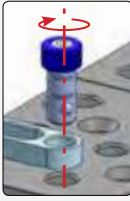

Finger tighten the knurled head after insertion to preload before tightening with Hex Key.

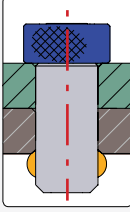

Three locking steel balls move outward to lock the bolt in position.

Ball Lock Bolts are key to the efficient set up of Modular Fixtures on your BuildPro® Tabletop. Use the Ball Lock Bolts to fasten clamping elements to the BuildPro® Tabletop, or fasten two clamping elements together.

Basic Hold Down Clamping:

- Inserta Clamps
- Sliding Channel Clamps
- Inserta Pliers
- Good Hand® Toggle Clamps

Stop, Position, & Locate Stock:

- Right Angle Brackets
- Straight Edge Stops
- Econo Stop & Clamping Squares
- Malleable Cast Iron Clamping Squares
- Heavy Duty Riser Blocks
- Stops, Rests, and V-Blocks

Clamps

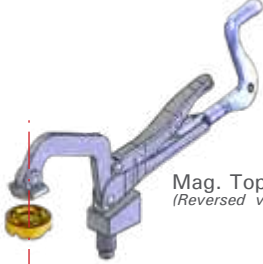

Inserta Pliers



Inserta Clamps

Mag. Top V-Pads
(Reversed view)

Quick hold-down clamping of flat, square, angled or round parts.

Locate / Stop

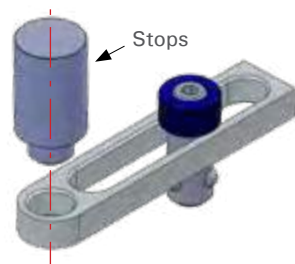

D-Stop Bars

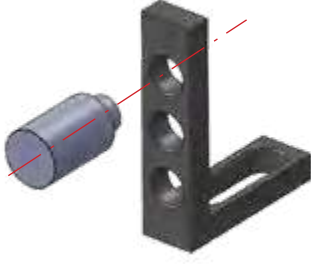

Right Angle Brackets

Stop, locate, and position parts.

Support Round Stock

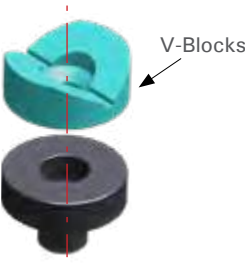

V-Block Spacers

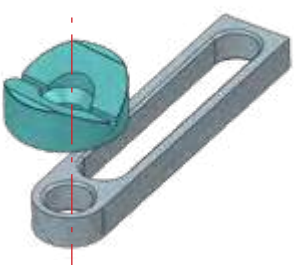

D-Stop Bars

Elevate and hold round parts.

Stop / Locate / Elevate

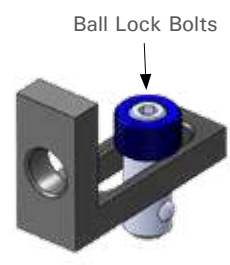

Ball Lock Bolts

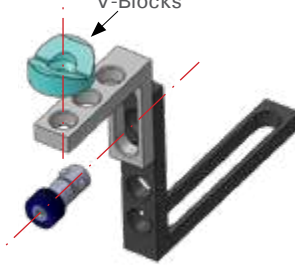

Right Angle Brackets

Stop and locate parts.

Stack Right Angle Brackets to elevate and hold round parts.

BUILDPRO® MAX TABLES

MAXIMUM TABLE SURFACE, MAXIMUM CAPACITY

Set-up heavy duty, large, or complex fixtures.

Set-up more than one fixture at a time on the larger surface.

Utilize the additional holes (33% more than slotted tables) for clamping at multiple points.

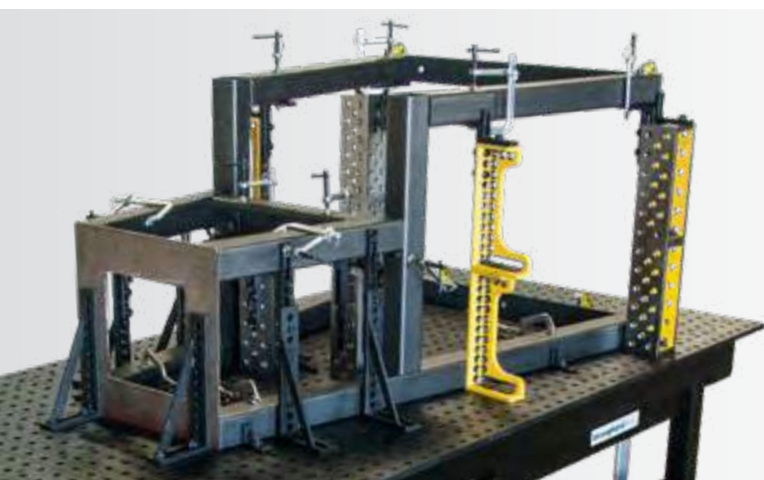
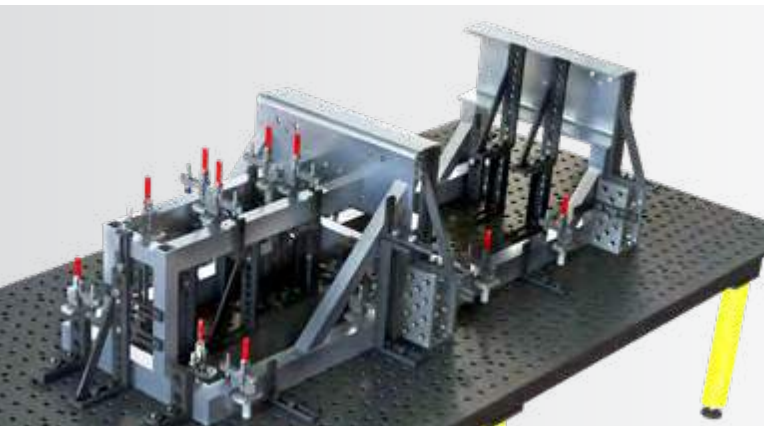

8' X 4' (NOMINAL)

TABLE SURFACE DIMENSION: 96" X 48" (ACTUAL)

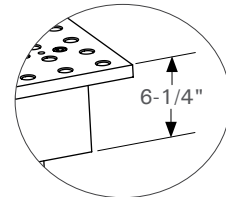

Optional Leg Brace Assy.

With Heavy Duty Leg



Part No.	Finish	Leg + Leveling Pad Height (in)	Table Surface Height (in)	* Capacity (lb)	Table Weight (lb)
TMA59648F	Standard	30-1/4	36-1/2	1,500 per leg	1,330
TMB59648F		24-1/4	30-1/2		1,310
TMQA59648F	Nitrided	30-1/4	36-1/2		1,330
TMQB59648F		24-1/4	30-1/2		1,310

Part No.	Leg Brace Assembly for	Weight (lb)
TMLB96	3" Dia. Heavy Duty Leg	26

With Adjustable Round Leg - Adjustable at 1" increments



Part No.	Finish	Leg + Leveling Pad Height (in)	Table Surface Height (in)	* Capacity (lb)	Table Weight (lb)
TMR59648F	Standard	22-1/4 ~ 32-1/4	28-1/2 ~ 38-1/2	1,500 per leg	1,335
TMQR59648F	Nitrided				

Part No.	Leg Brace Assembly for	Weight (lb)
TMLB96	3" Dia. Adjustable Leg	26

With Adjustable Round Leg & Mobility Caster



Part No.	Finish	Leg + Caster Height (in)	Table Surface Height (in)	* Capacity (lb)	Table Weight (lb)
TMRC59648F	Standard	27 ~ 37	33-1/4 ~ 43-1/4	650 per leg	1,375
TMQRC59648F	Nitrided				

Part No.	Leg Brace Assembly for	Weight (lb)
TMLB96	3" Dia. Adjustable Leg	26

*All load capacities are calculated based on static load.

4' X 4' (NOMINAL)

TABLE SURFACE DIMENSION: 48" X 48" (ACTUAL)

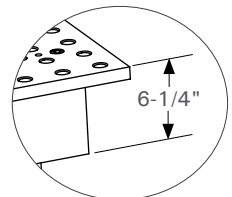
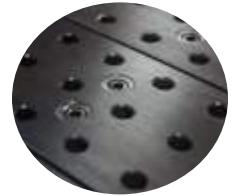

Optional Leg Brace Assy.

NEW ITEM

With Heavy Duty Leg



Part No.	Finish	Leg + Leveling Pad Height (in)	Table Surface Height (in)	* Capacity (lb)	Table Weight (lb)
TMA54848F	Standard	30-1/4	36-1/2	1,500 per leg	965
TMB54848F		24-1/4	30-1/2		955
TMQA54848F	Nitrided	30-1/4	36-1/2		965
TMQB54848F		24-1/4	30-1/2		955

Part No.	Leg Brace Assembly for	Weight (lb)
TMLB48	3" Dia. Heavy Duty Leg	15

With Adjustable Round Leg - Adjustable at 1" increments



Part No.	Finish	Leg + Leveling Pad Height (in)	Table Surface Height (in)	* Capacity (lb)	Table Weight (lb)
TMR54848F	Standard	22-1/4 ~ 32-1/4	28-1/2 ~ 38-1/2	1,500 per leg	970
TMQR54848F	Nitrided				

Part No.	Leg Brace Assembly for	Weight (lb)
TMLB48	3" Dia. Adjustable Legs	15

With Adjustable Round Leg & Mobility Caster



Part No.	Finish	Leg + Caster Height (in)	Table Surface Height (in)	* Capacity (lb)	Table Weight (lb)
TMRC54848F	Standard	27 ~ 37	33-1/4 ~ 43-1/4	650 per leg	1,000
TMQRC54848F	Nitrided				

Part No.	Leg Brace Assembly for	Weight (lb)
TMLB48	3" Dia. Adjustable Legs	15

*All load capacities are calculated based on static load.

8' X 4' (NOMINAL)

TABLE SURFACE DIMENSION: 94" X 46" (ACTUAL)

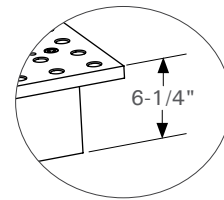
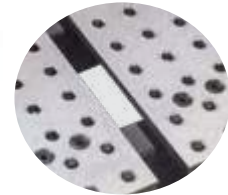

Optional Leg Brace Assy.

With Heavy Duty Leg

Part No.	Finish	Leg + Leveling Pad Height (in)	Table Surface Height (in)	* Capacity (lb)	Table Weight (lb)
TMA59446	Standard	30-1/4	36-1/2	1,500 per leg	990
TMB59446		24-1/4	30-1/2		970
TMQA59446	Nitrided	30-1/4	36-1/2		990
TMQB59446		24-1/4	30-1/2		970



Part No.	Leg Brace Assembly for	Weight (lb)
TMLB94	3" Dia. Heavy Duty Leg	25

With Adjustable Round Leg - Adjustable at 1" increments

Part No.	Finish	Leg + Leveling Pad Height (in)	Table Surface Height (in)	* Capacity (lb)	Table Weight (lb)
TMR59446	Standard	22-1/4 ~ 32-1/4	28-1/2 ~ 38-1/2	1,500 per leg	995
TMQR59446	Nitrided				



Part No.	Leg Brace Assembly for	Weight (lb)
TMLB94	3" Dia. Adjustable legs	25

With Adjustable Round Leg & Mobility Caster

Part No.	Finish	Leg + Caster Height (in)	Table Surface Height (in)	* Capacity (lb)	Table Weight (lb)
TMRC59446	Standard	27 ~ 37	33-1/4 ~ 43-1/4	650 per leg	1,035
TMQRC59446	Nitrided				



Part No.	Leg Brace Assembly for	Weight (lb)
TMLB94	3" Dia. Adjustable legs	25

*All load capacities are calculated based on static load.

6-1/2' X 4' (NOMINAL)

TABLE SURFACE DIMENSION: 78" X 46" (ACTUAL)

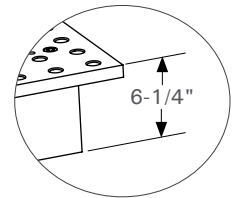
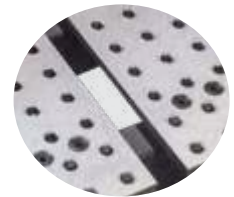

Optional Leg Brace Assy.



With Standard Leg

Part No.	Finish	Leg + Leveling Pad Height (in)	Table Surface Height (in)	* Capacity (lb)	Table Weight (lb)
TMA57846	Standard	31-3/8	37-5/8	1,000 per leg	760
TMB57846		25-1/2	31-3/4		745
TMQA57846	Nitrided	31-3/8	37-5/8		760
TMQB57846		25-1/2	31-3/4		745

Part No.	Leg Brace Assembly for	Weight (lb)
TMLB78	2-1/4" Dia. Standard legs	19



With Adjustable Round Leg - Adjustable at 1" increments

Part No.	Finish	Leg + Leveling Pad Height (in)	Table Surface Height (in)	* Capacity (lb)	Table Weight (lb)
TMR57846	Standard	22-1/4 ~ 32-1/4	28-1/2 ~ 38-1/2	1,500 per leg	790
TMQR57846	Nitrided				

Part No.	Leg Brace Assembly for	Weight (lb)
TMLBR78	3" Dia. Adjustable legs	22



With Adjustable Round Leg & Mobility Caster

Part No.	Finish	Leg + Caster Height (in)	Table Surface Height (in)	* Capacity (lb)	Table Weight (lb)
TMRC57846	Standard	27 ~ 37	33-1/4 ~ 43-1/4	650 per leg	825
TMORC57846	Nitrided				

Part No.	Leg Brace Assembly for	Weight (lb)
TMLBR78	3" Dia. Adjustable legs	22

*All load capacities are calculated based on static load.

6-1/2' X 3' (NOMINAL)

TABLE SURFACE DIMENSION: 78" X 38" (ACTUAL)

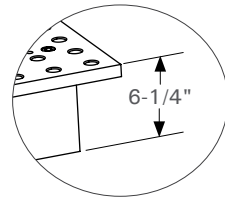
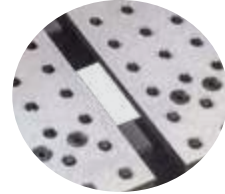

Optional Leg Brace Assy.

With Standard Leg

Part No.	Finish	Leg + Leveling Pad Height (in)	Table Surface Height (in)	* Capacity (lb)	Table Weight (lb)
TMA57838	Standard	31-3/8	37-5/8	1,000 per leg	680
TMB57838		25-1/2	31-3/4		665
TMQA57838	Nitrided	31-3/8	37-5/8		680
TMQB57838		25-1/2	31-3/4		665

Part No.	Leg Brace Assembly for	Weight (lb)
TMLB78	2-1/4" Dia. Standard legs	19

With Adjustable Round Leg - Adjustable at 1" increments

Part No.	Finish	Leg + Leveling Pad Height (in)	Table Surface Height (in)	* Capacity (lb)	Table Weight (lb)
TMR57838	Standard	22-1/4 ~ 32-1/4	28-1/2 ~ 38-1/2	1,500 per leg	710
TMQR57838	Nitrided				

Part No.	Leg Brace Assembly for	Weight (lb)
TMLBR78	3" Dia. Adjustable legs	22

With Adjustable Round Leg & Mobility Caster

Part No.	Finish	Leg + Caster Height (in)	Table Surface Height (in)	* Capacity (lb)	Table Weight (lb)
TMRC57838	Standard	27 ~ 37	33-1/4 ~ 43-1/4	650 per leg	745
TMQRC57838	Nitrided				

Part No.	Leg Brace Assembly for	Weight (lb)
TMLBR78	3" Dia. Adjustable legs	22

*All load capacities are calculated based on static load.



4' X 4' (NOMINAL)

TABLE SURFACE DIMENSION: 47" X 46" (ACTUAL)

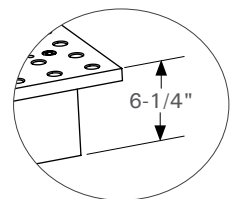
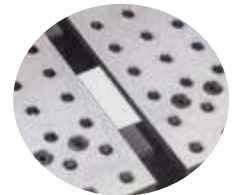

Optional Leg Brace Assy.



With Standard Leg

Part No.	Finish	Leg + Leveling Pad Height (in)	Table Surface Height (in)	* Capacity (lb)	Table Weight (lb)
TMA54746	Standard	31-3/8	37-5/8	1,000 per leg	465
TMB54746		25-1/2	31-3/4		460
TMQA54746	Nitrided	31-3/8	37-5/8		465
TMQB54746		25-1/2	31-3/4		460

Part No.	Leg Brace Assembly for	Weight (lb)
TMLB47	2-1/4" Dia. Standard legs	14



With Adjustable Round Leg - Adjustable at 1" increments

Part No.	Finish	Leg + Leveling Pad Height (in)	Table Surface Height (in)	* Capacity (lb)	Table Weight (lb)
TMR54746	Standard	22-1/4 ~ 32-1/4	28-1/2 ~ 38-1/2	1,500 per leg	490
TMQR54746	Nitrided				

Part No.	Leg Brace Assembly for	Weight (lb)
TMLBR47	3" Dia. Adjustable legs	15



With Adjustable Round Leg & Mobility Caster

Part No.	Finish	Leg + Caster Height (in)	Table Surface Height (in)	* Capacity (lb)	Table Weight (lb)
TMRC54746	Standard	27 ~ 37	33-1/4 ~ 43-1/4	650 per leg	510
TMQRC54746	Nitrided				

Part No.	Leg Brace Assembly for	Weight (lb)
TMLBR47	3" Dia. Adjustable legs	15

*All load capacities are calculated based on static load.

4' X 3' (NOMINAL)

TABLE SURFACE DIMENSION: 47" X 38" (ACTUAL)

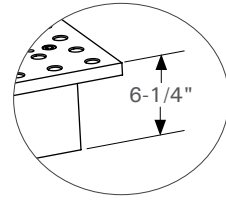
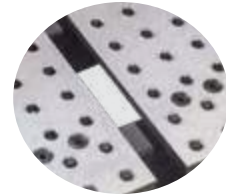

Optional Leg Brace Assy.

With Standard Leg



Part No.	Finish	Leg + Leveling Pad Height (in)	Table Surface Height (in)	* Capacity (lb)	Table Weight (lb)
TMA54738	Standard	31-3/8	37-5/8	1,000 per leg	415
TMB54738		25-1/2	31-3/4		410
TMQA54738	Nitrided	31-3/8	37-5/8		415
TMQB54738		25-1/2	31-3/4		410

Part No.	Leg Brace Assembly for	Weight (lb)
TMLB47	2-1/4" Dia. Standard legs	14

With Adjustable Round Leg - Adjustable at 1" increments



Part No.	Finish	Leg + Leveling Pad Height (in)	Table Surface Height (in)	* Capacity (lb)	Table Weight (lb)
TMR54738	Standard	22-1/4 ~ 32-1/4	28-1/2 ~ 38-1/2	1,500 per leg	440
TMQR54738	Nitrided				

Part No.	Leg Brace Assembly for	Weight (lb)
TMLBR47	3" Dia. Adjustable legs	15

With Adjustable Round Leg & Mobility Caster



Part No.	Finish	Leg + Caster Height (in)	Table Surface Height (in)	* Capacity (lb)	Table Weight (lb)
TMRC54738	Standard	27 ~ 37	33-1/4 ~ 43-1/4	650 per leg	460
TMQRC54738	Nitrided				

Part No.	Leg Brace Assembly for	Weight (lb)
TMLBR47	3" Dia. Adjustable legs	15

*All load capacities are calculated based on static load.

2' X 3' (NOMINAL)

TABLE SURFACE DIMENSION: 22" X 38" (ACTUAL)

* 2' x 4' Tables are also available. Please check www.BuildProTables.com for details.

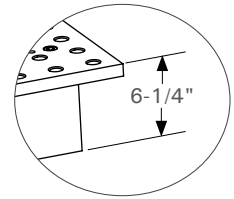
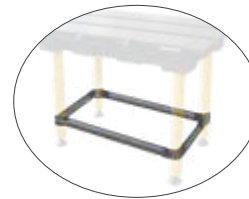
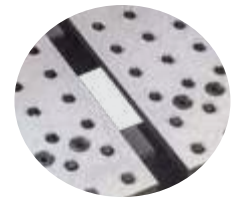

Optional Leg Brace Assy.

With Standard Leg

Part No.	Finish	Leg + Leveling Pad Height (in)	Table Surface Height (in)	* Capacity (lb)	Table Weight (lb)
TMA52238	Standard	31-3/8	37-5/8	1,000 per leg	255
TMB52238		25-1/2	31-3/4		245
TMQA52238	Nitrided	31-3/8	37-5/8		255
TMQB52238		25-1/2	31-3/4		245

Part No.	Leg Brace Assembly for	Weight (lb)
TMLB22	2-1/4" Dia. Standard legs	11

With Adjustable Round Leg - Adjustable at 1" increments

Part No.	Finish	Leg + Leveling Pad Height (in)	Table Surface Height (in)	* Capacity (lb)	Table Weight (lb)
TMR52238	Standard	22-1/4 ~ 32-1/4	28-1/2 ~ 38-1/2	1,500 per leg	275
TMQR52238	Nitrided				

Part No.	Leg Brace Assembly for	Weight (lb)
TMLBR22	3" Dia. Adjustable legs	13

With Adjustable Round Leg & Mobility Caster

Part No.	Finish	Leg + Caster Height (in)	Table Surface Height (in)	* Capacity (lb)	Table Weight (lb)
TMRC52238	Standard	27 ~ 37	33-1/4 ~ 43-1/4	650 per leg	300
TMQRC52238	Nitrided				

Part No.	Leg Brace Assembly for	Weight (lb)
TMLBR22	3" Dia. Adjustable legs	13

*All load capacities are calculated based on static load.



MAX TABLETOPS

(See pg. 5)

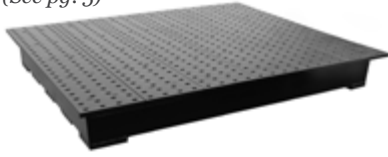

Part No.	Finish	Tabletop Dimension		Weight (lb)
		ft (nominal)	in (actual)	
TM59648V	Standard	8 x 4	96 x 48	1,270
TM54848V		4 x 4	48 x 48	905
TMQ59648V	Nitrided	8 x 4	96 x 48	1,270
TMQ54848V		4 x 4	48 x 48	905

SLOTTED TABLETOPS

(See pg. 5)



Part No.	Finish	Tabletop Dimension		Weight (lb)
		ft (nominal)	in (actual)	
TM59446SV	Standard	8 x 4	94 x 46	900
TM57846SV		6-1/2 x 4	78 x 46	690
TM57838SV		6-1/2 x 3	78 x 38	610
TM54746SV		4 x 4	47 x 46	420
TM54738SV		4 x 3	47 x 38	370
TM52246SV		2 x 4	22 x 46	235
TM52238SV		2 x 3	22 x 38	210
TMQ59446SV	Nitrided	8 x 4	94 x 46	900
TMQ57846SV		6-1/2 x 4	78 x 46	690
TMQ57838SV		6-1/2 x 3	78 x 38	610
TMQ54746SV		4 x 4	47 x 46	420
TMQ54738SV		4 x 3	47 x 38	370
TMQ52246SV		2 x 4	22 x 46	235
TMQ52238SV		2 x 3	22 x 38	210

LEVELING PAD FOR TABLETOPS



Part No.	L (in)	A (in)	Base Dia. (in)	Thread	Pitch (mm)	Weight (lb)
TML-02	4-3/4	2-1/4	3	M20	2.5	1.8

LEG BRACES

Leg Braces reinforce and stabilize the BuildPro® table. Ideal as a base for creating shelves. Place a metal plate or wooden board on the brace framework. Create one, or multiple level shelves with additional Leg Brace Assembly.



Part No.	Leg Brace Assembly for				Weight (lb)
	Table	Table Size (ft)	Legs Type	Leg Dia. (in)	
TMLB96	MAX	8 x 4	Heavy Duty	3	26
TMLB48	MAX	4 x 4	Heavy Duty	3	15
TMLB94	Slotted	8 x 4	Heavy Duty	3	25
TMLB78	Slotted	6-1/2 x 3 & 6-1/2 x 4	Standard	2-1/4	19
TMLB47	Slotted	4 x 3 & 4 x 4	Standard	2-1/4	14
TMLB22	Slotted	2 x 3 & 2 x 4	Standard	2-1/4	11
TMLBR78	Slotted	6-1/2 x 3 & 6-1/2 x 4	Adjustable	3	22
TMLBR47	Slotted	4 x 3 & 4 x 4	Adjustable	3	15
TMLBR22	Slotted	2 x 3 & 2 x 4	Adjustable	3	13

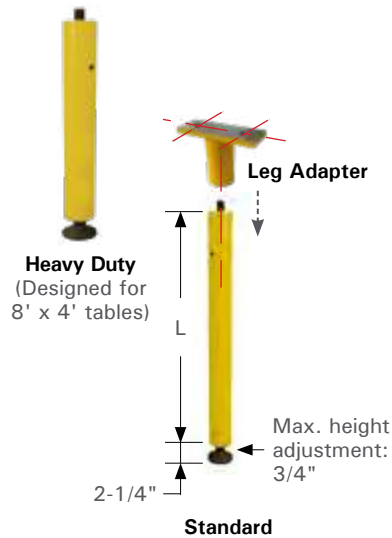
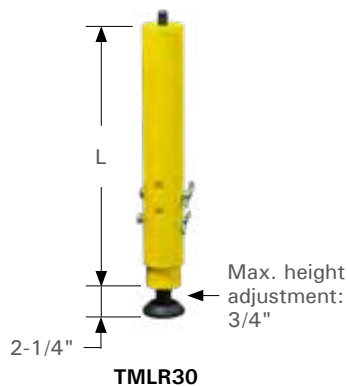

TABLE LEGS & SUPPORT LEG ADAPTER

Use the Support Leg Adapter + a BuildPro® Table Leg (M20 thread) to support extended table plates at the uniform table height. Screw the table leg into the threaded base of the Support Leg Adapter. Attach the Support Leg Adapter and Leg assembly to the extended table plate using two flush mount socket head shoulder screws (included with Leg Adapter).

Part No.	Description	Dia. (in)	Leg Height - L (in)	* L + Leveling Pad Height (in)	Weight (lb)
TML3130	Heavy Duty Leg for 36" height, 8' x 4' table	3	28	30-1/4	15
TML2530	Heavy Duty Leg for 30" height, 8' x 4' table	3	22	24-1/4	12
TML31	Standard Leg for 36" height	2-1/4	29-1/8	31-3/8	11
TML25	Standard Leg for 30" height	2-1/4	23-1/4	25-1/2	9

* Table Leg + Leveling Pad height is based on Leveling Pad height of 2-1/4".



Part No.	Description	Dia. (in)	Weight (lb)
TMLA5	Leg Adapter for use with TML31 & 25. <i>(Legs sold separately.)</i>	2-1/4	4

ADJUSTABLE LEG

Adjustable at 1" increments. Telescoping adjustable range (L) from 20" to 30" in height.

Part No.	Description	Dia. (in)	Leg Adjustable Range - L (in)	L + Leveling Pad Adjustable Range (in)	Weight (lb)
TMLR30	Adjustable Leg, Round	3	20 ~ 30	22-1/4 ~ 32-1/4	16.5

LEVELING CASTER



These compact, heavy duty leveling casters are the simple way to move and level your BuildPro® Welding Table.

This caster will add 3" to your total tabletop surface height.

* Sold individually.

Part No.	Capacity (lb)	Thread	Weight (lb)
TMLC600	1,100 each	M20	4.3

MOBILITY CASTER

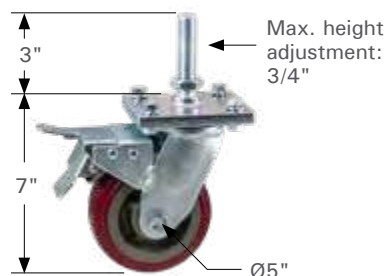

Durable caster rolls smoothly on precision ball bearings, with non-marking, non-marring nylon polymer wheels. Dual toe-step braking system can be set for "NO-SWIVEL + NO-ROLL".

This caster will add 5-3/4" to your total tabletop surface height.

* Sold individually.

Part No.	Capacity (lb)	Thread	Weight (lb)
TMLC700	650 each	M20	7.8

NEW ITEM

NEW ITEM

NEW ITEM

TABLE PLATFORM

ROTARY POSITIONERS



Horizontally mount your BuildPro® or Siegmund® Welding Tabletop to the New BuildPro® Rotary Positioner for plane rotation of your welding tabletop. The gear driven free-turning mechanism allows for smooth operation, superior stability and controlled turning and positioning at precise 15° increments with positive manual locking.

The BuildPro® Rotary Positioner allows you to rotate your weld fixture to the best ergonomic position for worker safety and comfort, and reduced operator fatigue. Position your fixture for better weld access, accuracy, and productivity for both manual and robotic welding operations.

The BuildPro® Rotary Positioner is universal, with an adjustable base to accommodate most standard BuildPro® or Siegmund® Welding Tabletops. The Positioner features four swiveling, locking casters, and four leveling feet for setup at dedicated or alternating locations in the shop.

*** POSITIONER CAPACITY: 2,400 LB.**



**Tabletop sold separately.*

PATENT PENDING

Table Mounting Brackets

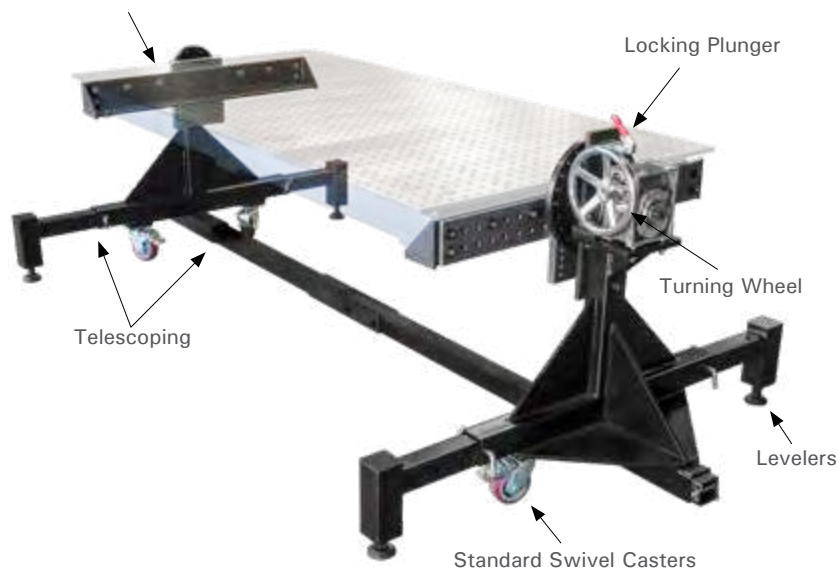

** For use with BuildPro® or Siegmund® System 16 Tabletops. Contact our Sales Team to request the Siegmund® Catalog.*



Our new adjustable outriggers allow greater stability when working with taller assemblies and can be retracted when not required.

By utilizing the extra mounting positions (1" increments) to lower the table, the new adjustment plates help shift the center of gravity when working with tall or heavy parts. This allows smoother rotation of assemblies up to 90° from horizontal.

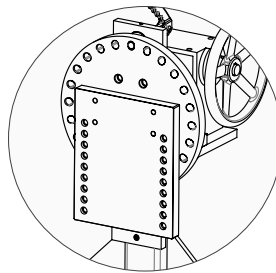

New adjustment plates included.

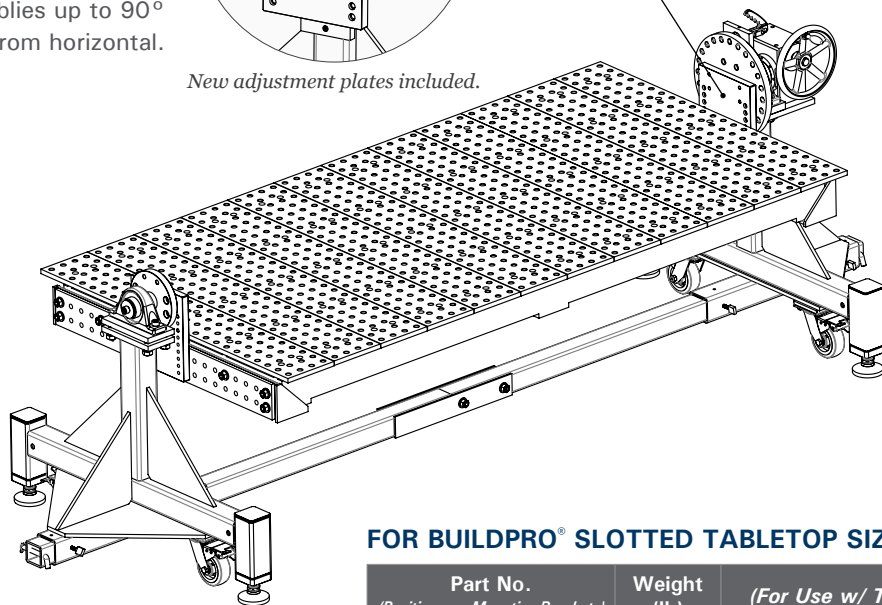

FOR BUILDPRO® MAX TABLETOP SIZE

Part No. <i>(Positioner + Mounting Brackets)</i>	Weight (lb)	<i>(For Use w/ Tabletop)</i>
TMP59648	926	TM(Q)59648V (8' x 4')
TMP54848	890	TM(Q)54848V (4' x 4')

FOR BUILDPRO® SLOTTED TABLETOP SIZE

Part No. <i>(Positioner + Mounting Brackets)</i>	Weight (lb)	<i>(For Use w/ Tabletop)</i>
TMP59446	884	TM(Q)59446SV (8' x 4')
TMP57846	870	TM(Q)57846SV (6.5' x 4')
TMP57838	870	TM(Q)57838SV (6.5' x 3')
TMP54746	848	TM(Q)54746SV (4' x 4')
TMP54738	848	TM(Q)54738SV (4' x 3')

**Tabletop sold separately.*

STATIONARY SCISSOR LIFT PLATFORMS



NEW ITEM



New Stationary Scissor Lifts increase productivity and worker comfort by setting your BuildPro® table at the ideal height for each project.

Quick-acting scissor lift platform raises loads up to 4,200 lb to from a range of 8.5" - 48" in height.

The large push button power control is operated by hand. Chip resistant powder coated finish.

Meets ANSI standards for Lift Tables.
* *Mounting Hardware Included.*

Part No.	Fits Tabletops	Travel (in)	Capacity (lb)	Platform Size (in)	Platform Height*		Voltage	Approx. Time (sec.)		Approx. Weight (lb)
					Lowered	Raised		Up	Down	
TMLK2-3648	TM(Q)54738SV	30	1,500	36 x 48	8.5	38.5	115 VAC	24	12	490
TMLK3-3648	TM(Q)54746SV	34	2,500	36 x 48	8.7	42.6	115 VAC	25	12	560
TMLK5-4872	TM(Q)57846SV	39	4,200	48 x 72	8.8	48	115 VAC	50	24	1,030

* Platform height without tabletop.

HD ERGONOMIC HEIGHT-ADJUSTABLE ELECTRIC ACTUATED LIFT PLATFORM



NEW ITEM

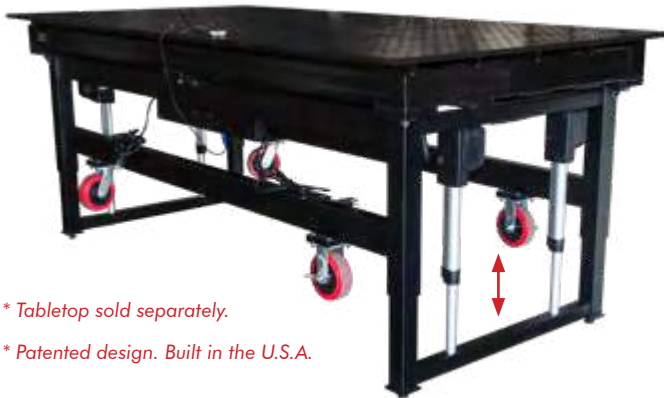

* Tabletop sold separately.

* Patented design. Built in the U.S.A.

This strong, rigid, vibration dampening platform operates smoothly with the use of a programmable switch.

Constructed from 11 / 14 ga thick steel columns with laser cut, welded horizontal supports made of 1/2" HRS steel plates.

Lock in the stationary position, or roll to desired location on 5" HD casters. Durable powder coated finish.

* Check our website BuildProTables.com for other sizes.

Part No.	Fits BuildPro Max 8' x 4' Tabletop	Travel (in)	Capacity (lb)	Platform Size (in)	Platform Height*		Voltage	Approx. Time (sec.)		Approx. Weight (lb)
					Lowered	Raised		Up	Down	
TMLT9648	TM(Q)59648V	12.5	6,500	96 x 48	28.5	41	115 VAC	40	40	600

* Platform height without tabletop.

TABLE PLATFORM

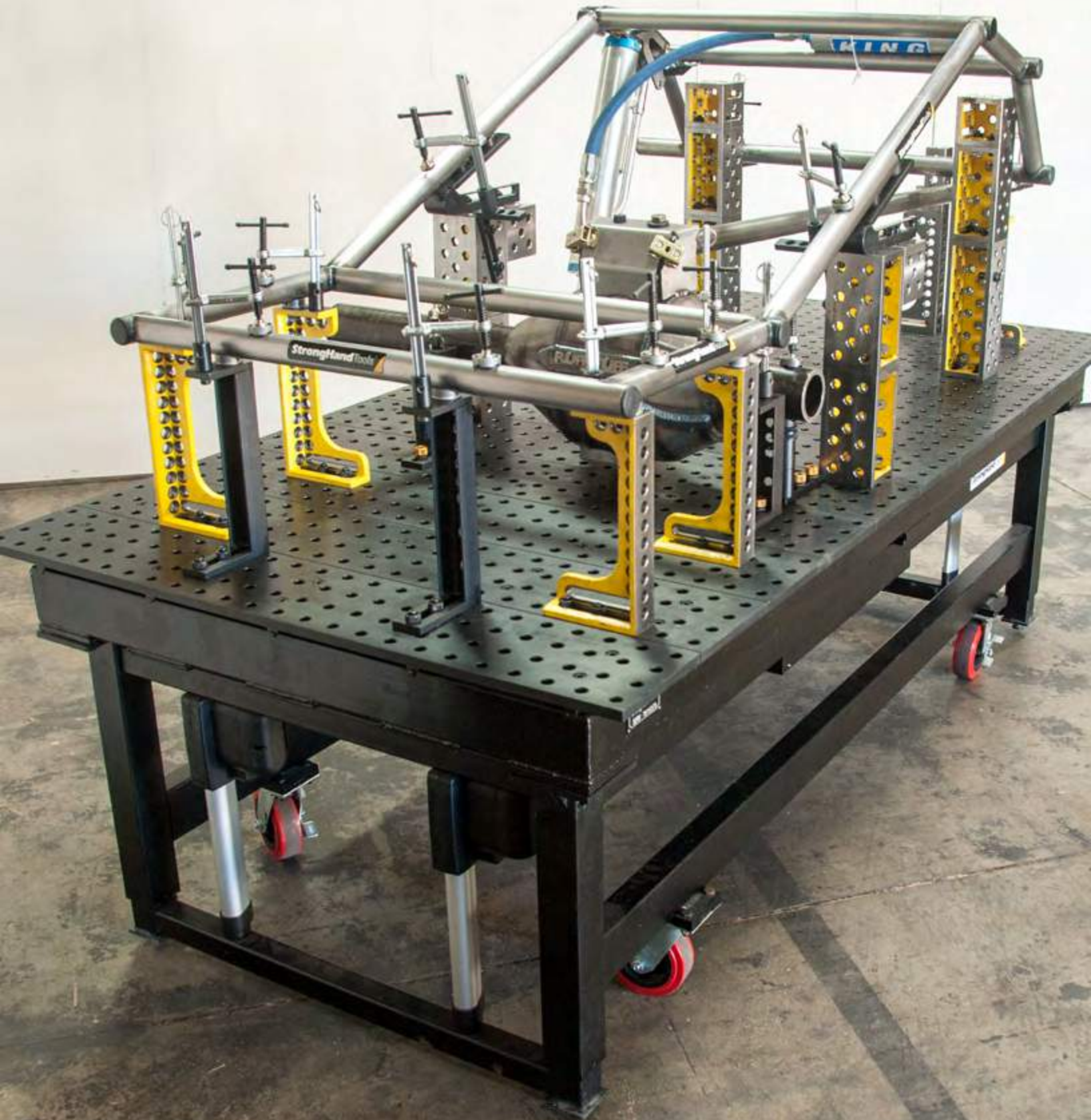

NEW ITEM

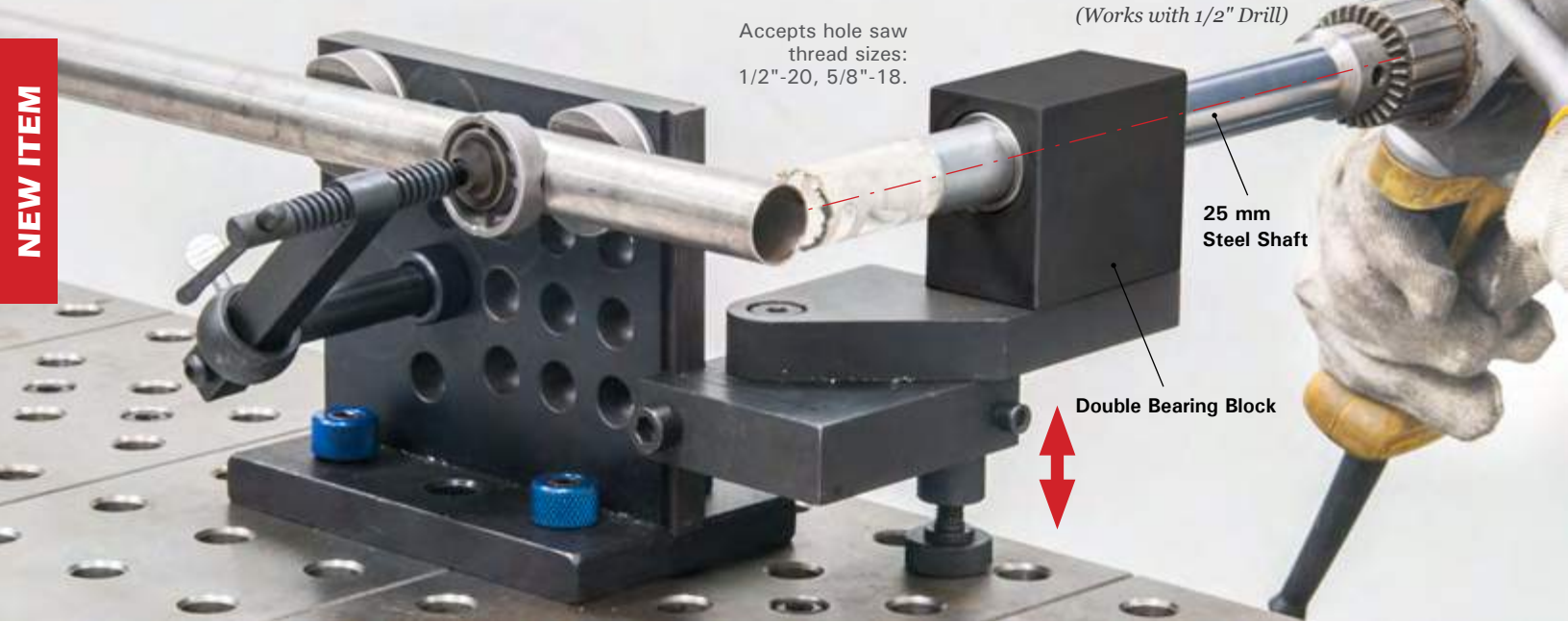

BuildPro® Tube & Pipe Notcher
(1 pc.)



Aluminum V-Blocks
(2 pcs.)



Clamp with Magnetic V-Pad
(1 pc.)

Use the New MODULAR BuildPro® Tube & Pipe Notcher for the accurate fixturing of parts.

The 1st notch in a tube or pipe is easily completed with a drill press. The BuildPro® Tube & Pipe Notcher makes alignment and length control of the 2nd notch easy to complete accurately.

Use BuildPro® Clamps and Components to fixture stock for accurate notching.

Notch 1" – 2-1/2" OD pipes or square tubes at any angle, or off-center. Position the two V-Blocks and clamp as needed.

Part No.	Kit Includes	Weight (lb)
ATN100	1 pc. BuildPro® Tube & Pipe Notcher 2 pcs. Aluminum V-Blocks for tube locating 1 pc. Clamp with Magnetic V-Pad	18

Add BuildPro® or Strong Hand Tools® clamps and components, as needed, to create custom setups for each new project.

The V-Pads have a soft face to protect the pipe or tube surface.

The cutter centerline is height adjustable to accommodate a wide variety of workpieces.

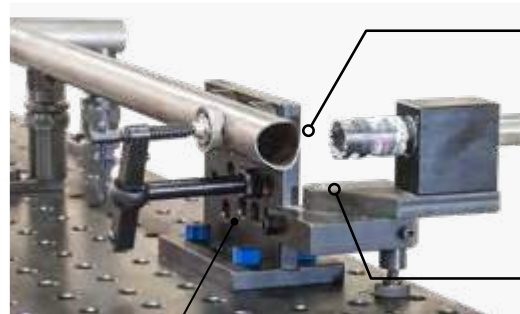

Arrange the Clamp and V-Blocks on the Modular Fixturing Block as needed for proper part positioning in each notching application.



Height Setting Scale



Angle Setting Scale

In the examples below, the BuildPro® Tube & Pipe Notcher is used to notch workpieces as needed to fit seamlessly into a final assembly:

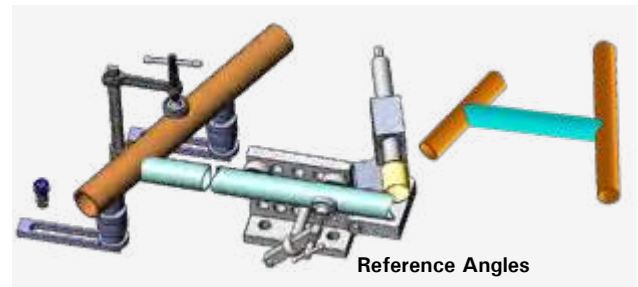
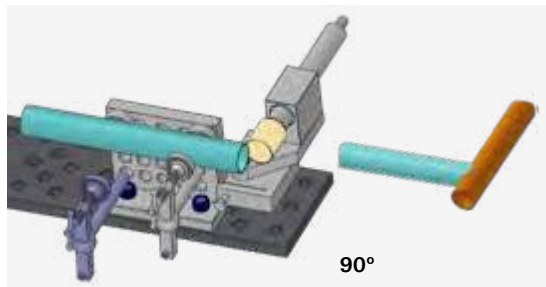
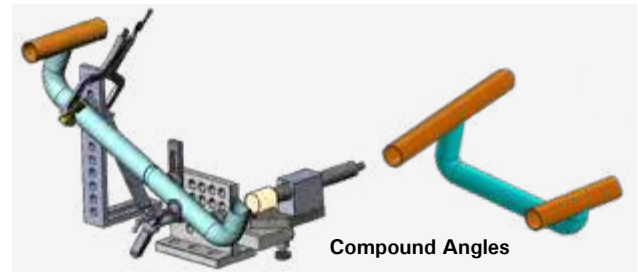
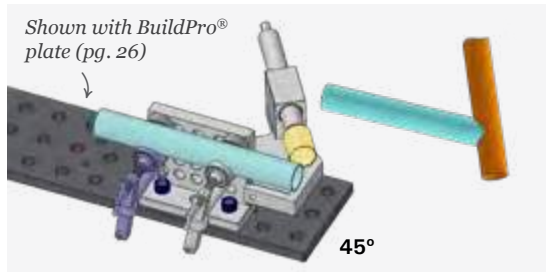

Mount your modular BuildPro® Tube & Pipe Notcher on the: BuildPro® tables / plates, Rhino Cart®, or FixturePoint® Welding Tables.

The chart below are some of the **OPTIONAL** BuildPro® and Strong Hand Tools® Clamps and Components used in the fixturing.



INSERTA CLAMPS
Part No. UEN5200
– See pg. 28



ROUND STOCK PLIERS
Part No. PG637V
– See pg. 33



STRAIGHT EDGE STOPS
Part No. T50505
– See pg. 33



RIGHT ANGLE BRACKETS
Part No. T50330
– See pg. 34



ADJUSTABLE REST
Part No. T54213
– See pg. 38



LOW PROFILE ADJUSTABLE REST
Part No. Series T54212
– See pg. 38

Notcher Kit accessories available separately:



CLAMP W/ MAGNETIC V-PAD
Part No. ATNC50



ALUMINUM V-BLOCKS
for tube positioning
Part No. T54216
– See pg. 40

NEW ITEM



SIDE BRACKET FOR TABLES

Locate or clamp your weldment at or beyond the table edge, by mounting the Side Bracket at the edge of your BuildPro standard or MAX Welding Table.

Use the Side Bracket to vertically mount clamping elements, such as the Straight Edge Stops or Right Angle Brackets to add greater functionality to your table in fixturing oversized weldments.

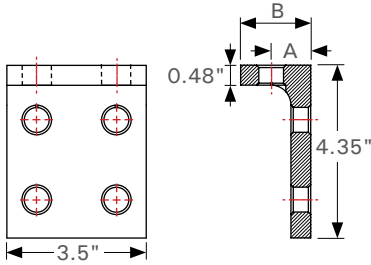

Part No.	A (in)	B (in)	Mounting Location	Weight (lb)
T51825	1	1.475	MAX Tables – END or SIDE Slotted Tables - END	2.5
T51830	1.18	1.7	Slotted Tables - SIDE	2.5

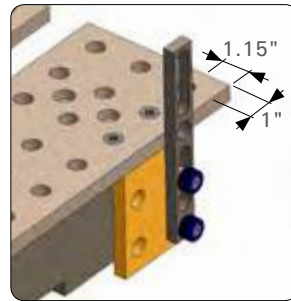
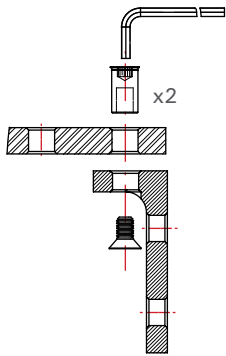

Slotted table shown

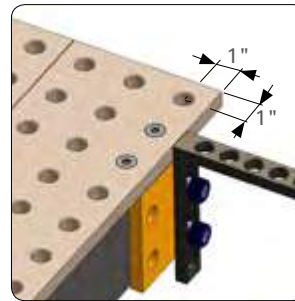

MAX table shown

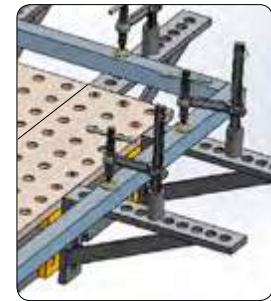

NEW DESIGN

INDIVIDUAL REVERSIBLE TABLE PLATES

See pg. 5 for information.

* Mounting hardware sold separately. See pg. 27 for ordering information.

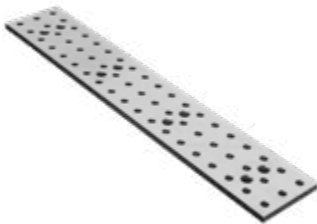

Part No.	Finish	Dimension (in)	Plate Thickness (in)	Weight (lb)
TM59648V-01	Standard	48 x 6	5/8	45
TM57846SV-01		46 x 6.3		48
TM57838SV-01		38 x 6.3		40
TMQ59648V-01	Nitrided	48 x 6		45
TMQ57846SV-01		46 x 6.3		48
TMQ57838SV-01		38 x 6.3		40

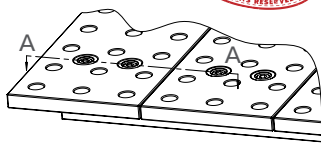

Section A-A

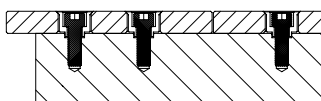

Other applications:





T51006



T51009



T52005-01

FIXTURING PLATES

The versatile plate can be used as a fixturing element, or as a link to connect two tables together.



Part No.	Finish	Description	Plate Thickness (in)	Weight (lb)
T51006	Standard	4" x 6.3" Fixturing Plate, 6 holes	5/8	4.2
T51009	Standard	6" x 6.3" Fixturing Plate, 9 holes	5/8	6.3
T52005-01	Nitrided	20" x 6.3" Fixturing Plate	5/8	20

LOCATING BUSHING

Locating Bushings allow you to remove, re-position, re-align, and reverse the table plates!



Part No.	Description	Weight (lb)
TM62010-04	Locating Bushing for table plate mounting, 0.866" O.D.	0.05

MOUNTING SCREWS 10 PC KIT

Must be used in conjunction with Locating Bushing for mounting BuildPro® Plates to the table frame.



Part No.	Description	Weight (lb)
T55310	10 pc. of M10 x 22 Mounting Socket Head Cap Screws	0.6

SIDE CLAMP

Insert into the Buildpro® table holes for low profile, light duty, horizontal clamping.

A turn of the aluminum knob advances the spindle, bringing the swivel foot to rest against the face of your stock or workpiece.

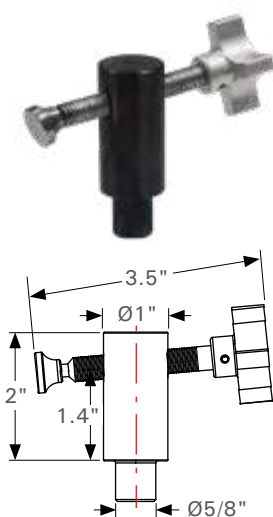

Part No.	Stroke (in)	Weight (lb)
TCX5210	1-1/2	0.6



T-Handle

UDN5150 | UEN5200



Ratchet Handle
UERN5200

INSERTA CLAMPS

Place the Inserta Clamps into the 5/8" holes on the BuildPro® Tabletop, Riser Blocks, Economy Stops or Clamping Squares for fast, easy clamping. Clamp in the vertical or horizontal position at any height.

The Ratchet Handle Model is ideal for tight space clamping, and the ratchet mechanism ensures rapid, vibration and torsion resistant clamping.

Clip the optional Top V-Pads (pg. 29) onto the top spindle to clamp round or angled stock. Remove the clamp arm by depressing the spring stop, and slide the Sidekick attachment (pg. 29) onto the clamp bar, followed by the clamp arm, for two point horizontal and vertical clamping force.



Part No.	Clamping Capacity (in)	Throat Depth (in)	Clamping Pressure (lb)	Rail Size (in)	Weight (lb)
UDN5150	6-1/2	3-1/4	300	5/8 x 5/16	1.2
UEN5200	8-1/2	4	400	25/32 x 3/8	2.2
UERN5200	8-1/2	4	400	25/32 x 3/8	2.2

SLIDING CHANNEL CLAMPS *

The 360° Sliding Channel Clamp slides into the 1.7" spacing between plates which enables the clamp body to slide along the entire surface and swivel 360° for positioning at any point.



Part No.	Clamping Capacity (in)	Throat Depth (in)	Clamping Pressure (lb)	Rail Size (in)	Weight (lb)
T51405	8-1/2	4-3/4	500	7/8 x 7/16	3.5
T51510	12-1/2	4-3/4	600	1 x 15/32	4.8
T51615	20-1/2	5-1/2	700	1-3/16 x 9/16	8.2

* Not applicable to BuildPro® MAX table.



CLAMP ACCESSORIES: SIDEKICKS

Slide the Sidekick onto the clamp rail of Inserta Clamps and Sliding Channel Clamps for horizontal clamping force.



Part No.	For Inserta Clamps	For Sliding Channel Clamps	Stroke (in)	Weight (lb)
XDS	UDN5150	--	1	0.6
XFS	--	T51405	1-3/8	1.2
XGS	--	T51510	1-3/8	1.2
XMS	--	T51615	1-3/8	1.2

CLAMP ACCESSORIES: V-PADS

Optional clip-on top V-pad for clamping round parts or 2 parts at once.

V-Pad clips onto the swivel pad of Inserta Clamps and Sliding Channel Clamps.



Alum. Magnetic Top V-Pad
T54217 | T54219



Clip-on Top V-Pads



Stainless Steel V-Pads
XDA2S | XFA2S

	Part No.	For Inserta Clamps	For T-Post Clamps	For Sliding Channel Clamps	Weight (lb)
ALUM.	T54217	UDN5150 & UDWN5150	T51650, T51655, T51670	--	0.05
	T54219	UEN5200	--	T51405 & T51510	0.05
S.S.	XDA2	UDN5150 & UDWN5150	T51650, T51655, T51670	--	0.2
	XFA2	UEN5200 & UEWN5200	--	T51405 & T51510	0.4
	XMA2	--	--	T51615	0.6
	XDA2S	UDN5150 & UDWN5150	T51650, T51655, T51670	--	0.2
	XFA2S	UEN5200 & UEWN5200	--	T51405 & T51510	0.4



NEW ITEM

NEW ITEM

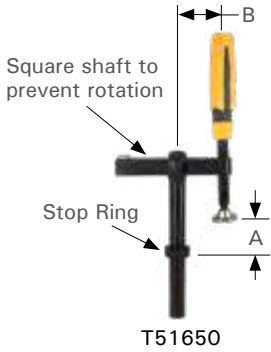

T51650



T51655

T-POST CLAMPS

Place the Adjustable T-Post Clamp in any of the Ø5/8" holes on the BuildPro® Tabletop or Heavy Duty Riser Blocks for vertical hold down clamping.

Adjust the clamp arm along the vertical or horizontal axis for each unique hold down application. Adjustable arm provides precise clamping location by sliding the spindle to any desired pressure point.

Move the Stop Ring as needed to set the height of the clamp.

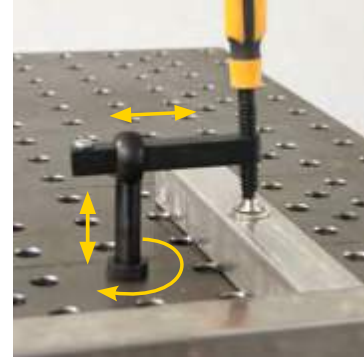

Part No.	Handle	Clamping Capacity A (in)	Throat Depth B (in)	Weight (lb)
T51650	Straight	Max. 4-1/2	1-3/4 - 3-1/4	1.4
T51655	T-Handle	Max. 4-1/2	1-3/4 - 3-1/4	1.4

NEW ITEM

Multi-Directional PIVOTING T-POST CLAMP

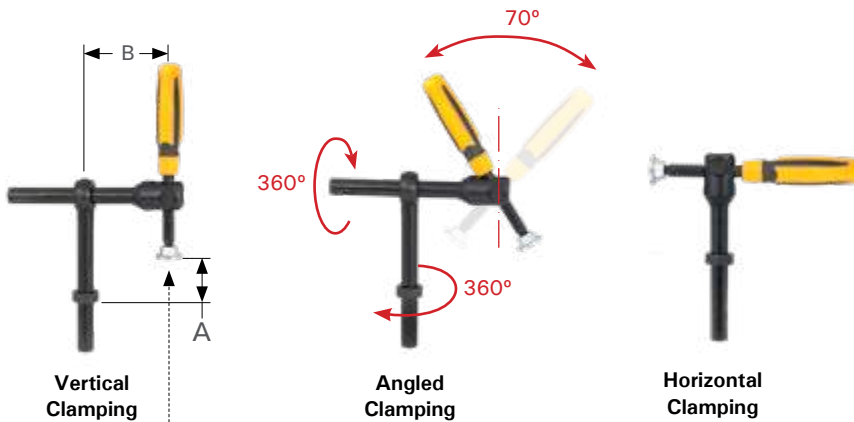

A magnetic top V-Pad (Part No. T54217) is INCLUDED for clamping round stock and square tubing edges.

Use the versatile Pivoting T-Post Clamp to apply angled clamping force. Clamp stock horizontally and vertically.

For **VERTICAL** hold down clamping, or **ANGLED** clamping, place the fixed Vertical Clamp arm, with Pivoting Spindle, in the clamp post.

For **HORIZONTAL** clamping, remove the fixed Vertical Clamp arm and Pivoting Spindle from the clamp post, and place directly into the tabletop holes.

Part No.	Clamping Capacity A (in)	Throat Depth B (in)	Weight (lb)
T51670	Max. 4-1/2	1-3/4 - 5	1.8





ADJ. MOUNTING BASE for GOOD HAND® TOGGLE CLAMPS

Mount any of the seven *Good Hand*® Toggle Clamps listed below on this low-profile, pre-tapped Adjustable Mounting Base. Mount Toggle Clamps directly on the BuildPro® Tabletop, Riser Blocks or Econo Stop & Clamping Squares, for the height and reach required for each hold down application.

The thickness of the Aluminum base adds 5/8" to the maximum capacity of the Toggle Clamp.

Use Ball Lock Bolts (not included), to mount the Straight Edge Stop attachment. See pg. 44 for details.

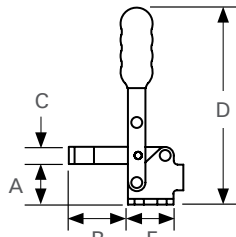

Vertical

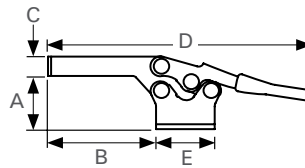

Horizontal

	Part No.	Mounting Hole (in)	A (in)	B (in)	C (in)	D (in)	E (in)	Weight (lb)
Vertical	GH-12050	4 x Ø.20	0.89	1.3	0.38	3.74	1	0.4
	GH-12050-HB	4 x Ø.20	1.66	1.3	0.38	4.80	1	0.4
	GH-12130	4 x Ø.28	1.25	2.8	0.63	5.5	1.4	0.8
	GH-12130-HB	4 x Ø.28	2.25	2.8	0.63	6.5	1.4	0.9
Horizontal	GH-12265	4 x Ø.34	1.75	3.3	0.8	7.5	1.9	1.4
	GH-225-D	4 x Ø.26	1.37	2.8	0.5	6.8	1.5	0.6
	GH-225-DHB	4 x Ø.26	2.13	2.8	0.5	6.6	1.5	0.6

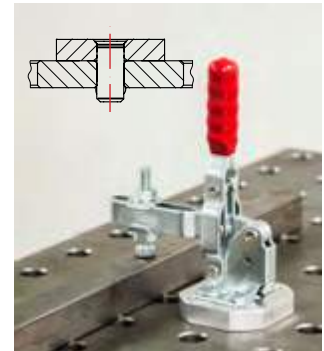

Directly mounted on the table using Flush Mount Ball Lock Bolt.



Mounted with Straight Edge Stop attachment and Ball Lock Bolts.

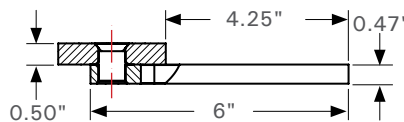
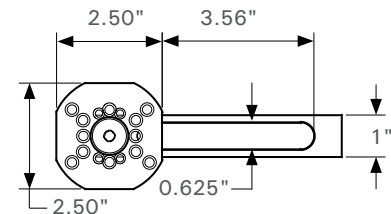
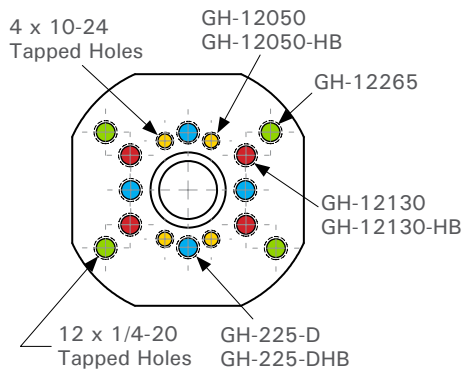

T50505GH-01



T50505GH

Part No.	Description	Weight (lb)
T50505GH-01	Pre-tapped Alum. Base ONLY.	0.3
T50505GH	Includes: pre-tapped Alum. Base + Straight Edge Stop + Flush Mount Screw.	0.7



NEW ITEM

INSERTA PLIERS

Insert into $\text{Ø}5/8"$ for fast hold-down clamping.

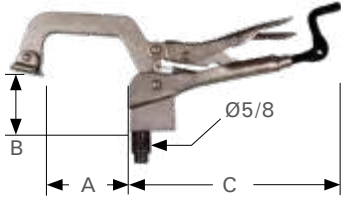

Mount on the Right Angle Bracket, Riser Block, or Clamping Squares for push down clamping at an elevated height for taller workpieces. The patented rear crank handle allows clamp pressure adjustment while the clamp is in locked position. Use the crank handle to pre-set the clamp opening in repetitious clamping applications.



** Can be used with Magnetic Top V-Pads. See pg. 29.*

Part No.	Throat Depth A (in)	Opening B (in)	C (in)	Weight (lb)
PTT522K	2	2-3/8	6	0.7
PTT634K	3	4	8	0.9
PTT934K	3-3/8	4	10-1/2	1.6
PTT956K	6-1/8	4-3/4	10-1/2	2.0



LOCKING CHAIN PLIERS W/ BASES



PFC1024

** See www.stronggrips.com for different chain sizes.*

Clamp odd shaped multiple items. Adjust tension with crank handle.

Part No.	Chain Length (in)	Holds Pipes (in)	Weight (lb)
PFC1024	24	up to 6.5	1.9

Mount to the BuildPro tabletop using Ball Lock Bolts [not incl.]. See pg. 44.

Part No.	Description	Weight (lb)
PXC90	Table Mount Base Kit (2 pc.)	1.1



PXC90

ROUND STOCK PLIERS



These Pliers feature a rotating V-Pad on the top jaw, and an adjustable swivel head spindle on the bottom jaw for the secure clamping of round pipes, up to 2-1/2" in diameter, against a flat surface.

Part No.	OAL (in)	Throat Depth (in)	Opening (in)	Weight (lb)
PG637V	8-1/2	3	2-1/2	1.0



MAGSPRING CLAMPS



The spring-loaded, one-handed clamp with quick-set, magnetic V-Pad. Quick and easy to use! Squeeze to open, set in position and turn to tighten. 500 lb clamping pressure.

Part No.	Opening (in)	Throat Depth (in)	Weight (lb)
UDV45	3	3-1/4	1.0
UDV65	4-1/2	3-1/4	1.1



* Try the new Magnetic Top V-Pads. See pg. 29.



Magnetic V-Pad keeps Clamp in position on steel surfaces.

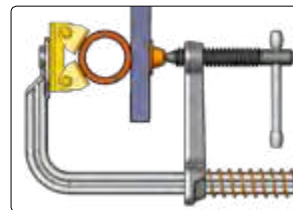

V-Pad adjusts to hold round, flat, and angled steel surfaces.



STRAIGHT EDGE STOPS



T50505 T50510 T50517

Long slots make these precision machined Straight Edge Stops infinitely adjustable in fixturing applications and squaring up parts.

Use with V-Blocks (see pg. 40) for the adjustable fixturing of round tubes.

Part No.	Dimension (in)	Ø.625 Holes	Slot Length (in)	Weight (lb)
T50505	6 x 1.18 x 0.47	1	3.5	0.6
T50510	8 x 1.18 x 0.47	2	2	0.8
T50517	10 x 1.18 x 0.47	4	5	0.9



Adjustable fixturing with V-Blocks

NEW ITEM

D-STOP BARS

Unique and versatile D-Stop Bars, with spring loaded plungers, are an efficient way to locate and position stock against a stop.

The D-Stop Bars are "distortion tolerant", for welded structures allowing easy part removal. They consist of a rounded end stop, a flat end stop, and long stop edges, and can be locked into position with Ball Lock Bolts (pg. 44), or Socket Head Shoulder Screws (pg. 45). Use the round end to locate any round or irregular shaped parts. Full length slots give you numerous mounting positions.

The Anodized Aluminum D-Stop Bars are lightweight and easy to maneuver. Mount D-Stop Bars using 3/8-16" hex head screw and Threaded Adapters, (sold separately) Part Nos. TXT5204 or TXT5304. See pg. 43.

Part No. T50632-01 does not include the washer, spring loaded pin, and 3/8" hex head screw. Mount to the tabletop using Ball Lock Bolts or Socket Head Screws.

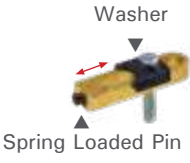

T50615



T50632-01



T50635

* 0.47" and 0.5" thicknesses for use as spacers.



Use the round end to hold against curved or odd shaped stock.



The spring loaded pin provides variable pressure for the quick locating, placement and removal of stock.



Part No.	Dimension (in)	Slot Length (in)	Threaded Holes	Threaded Hole Distance (in)	Weight (lb)
T50615	3.6 x 1 x 0.5	2.4	2 x M4	0.65	0.1
T50632-01	4.8 x 1 x 0.47	3	--	--	0.1
T50635	6.2 x 1.25 x 0.5	4.6	2 x M5	0.87	0.2

* Two threaded holes for mounting toggle clamps / accessories.

RIGHT ANGLE BRACKETS

These precision machined angle squares hold material at 90°. The holes and slots combination allow for infinite adjustments in fixturing. For heavy duty applications, see the Riser Blocks on pg. 35.



Part No.	Dimension (in)	Plate Thickness (in)	Holes	Slot Length (in)	Weight (lb)
T50304	1.6 x 3.6 x 1.18	0.47	1	2.6	0.5
T50305	3.6 x 3.6 x 1.18		3	2.6	0.7
T50310	3.6 x 6 x 1.18		3	5	1.0
T50320	7.6 x 6 x 1.18		7	5	1.3
T50330	12 x 6 x 2		11	5	4.5



Insert V-Blocks to support round stock.



ECONO STOP & CLAMPING SQUARES



Economy Stop and Clamping Squares feature three surfaces for use in a wide variety of fit up applications. Place Inserta Pliers or Inserta Clamps into any of the CNC machined holes for horizontal or vertical clamping at any height. Stack the Clamping Squares to brace tall workpieces. Use the top holes for mounting the Squares in a fixed location. The lower base is slotted for adjustable mounting.



Part No.	Dimension (in)	Weight (lb)
T50205	2 x 4.5 x 4	2.3
T50210	2 x 5.5 x 8	3.1
T50215	2 x 5.5 x 12	4.2

MALLEABLE IRON CLAMPING SQUARES



Versatile four-sided Clamping Squares. 26 Holes and 2 Slots on each. CNC machined faces.



Part No.	Description	Dimension (in)	Weight (lb)
T50231	Left Angle	2 x 6 x 12	6.4
T50230	Right Angle	2 x 6 x 12	6.4

HEAVY DUTY RISER BLOCKS

SLOTTED END FOR ADJUSTABLE MOUNTING



These five face precision machined Riser Blocks feature accurate bored holes in a diagonal pattern.



Use Riser Blocks individually, or stacked, to elevate a workpiece or clamp. Cross join the Blocks for use as a beam. Use the Blocks to mount a BuildPro® plate to the side or end of the table, or to join tables together.

Models T50120, T50125, and T50130 feature two slots at one end for adjustable positioning.



Part No.	Machined Surfaces	Dimension (in)	Weight (lb)
T50115	4 faces	2 x 2 x 10	4.4
T50120	5 faces	4 x 4 x 4	7.5
T50125		4 x 4 x 8	12.6
T50130		4 x 4 x 12	17.4

UNIVERSAL FLANGE CLAMPING PLATE



NEW ITEM

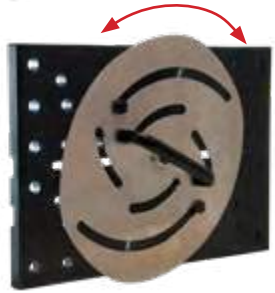

Inserta Pliers



Locating Pins

Hold ASME / ANSI / DIN Standard Flanges in position for flange + pipe joining!

Reduce set-up time and increase weld quality for greater repeatability.

Hold, accurately locate, and securely clamp down standard flanges. Guide Blocks in the Flange Clamping Plate expand or contract symmetrically to accurately locate the flange for greater weld quality. The patent pending Flange Clamping Plate provides full welding clearance, and allows easy removal of the finished weldment.

Fits standard flanges with these specifications:

- Hole circle diameter range: 3" – 18.3"
- Number of bolt holes: 4, 8, 12, 16

Part No.	Kit Includes	Dimension (in)	Weight (lb)
T50430	1 pc. Universal Flange & Pipe Clamping Plate w/ 8 Locating Pins: 2 of each size - 1", 7/8", 3/4", 5/8"; 2 pc. Part No. PTT634KF Inserta Pliers.	18 x 12 x 3/4	42.7

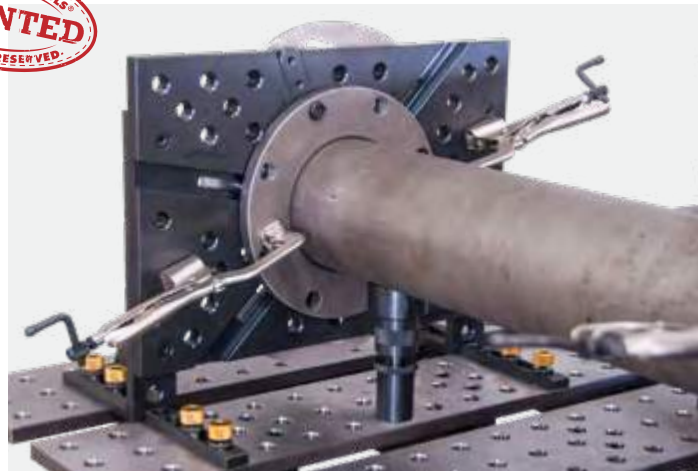

The fixture is strong and rigid, to withstand cumulative stresses resulting from welding, and holds the joined flange & pipe during cool down to prevent distortion, expansion, and contraction.

Load the flange & pipe, accurately position, and unload quickly for quality welds, maximum productivity, and repeatability.

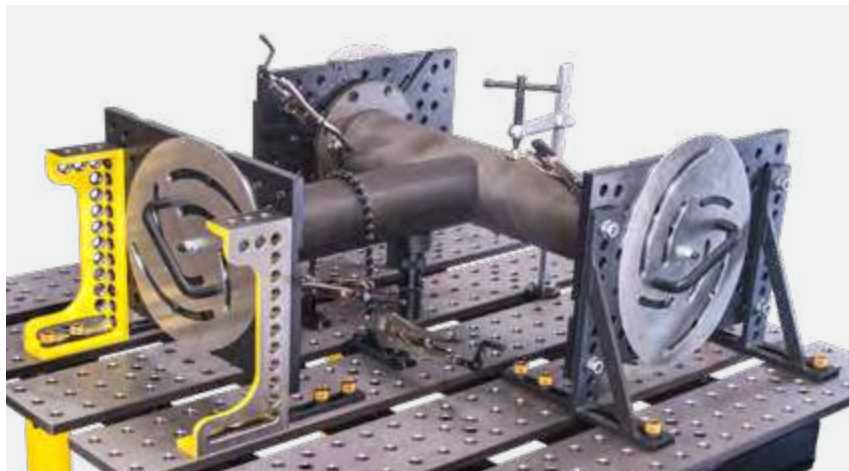

Use multiple Universal Flange & Pipe Fixtures to setup pipes for a T-Joint.

Find the fixturing video on:
youtu.be/dww1Xj1KfHc



** All accessories sold separately. See pg. 52 for "Suggested Parts List".*

SLOT FILLER KIT *

Use the Channel Block and Rest Button when a flat, continuous support surface is required directly over the 1.7" table slots. Place the 3-hole Channel Block beneath BuildPro® plates, aligning with plate holes, and mount with Flush Mount Socket Head Shoulder Screws (included).

Place the Rest Button in the center hole of the Channel Block to provide a rigid work surface level with the tabletop. The 5/8" shank on the Rest Button slip fits into the Channel Block holes. To elevate a workpiece above the tabletop surface, place multiple Rest Buttons directly into the 5/8" holes on the BuildPro® Plate.

Kit T50930 includes:

- 1 pc. Channel Block (T51003) 6.3" x 1.6" x 0.63"
- 1 pc. Rest Button (T54200)
- 2 pc. Flush-mounted Screws (T832612)



Slot Filler Kit T50930

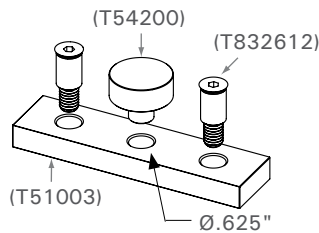

Part No.	Weight (lb)
T50930	2.4

* Not applicable to BuildPro® MAX table.

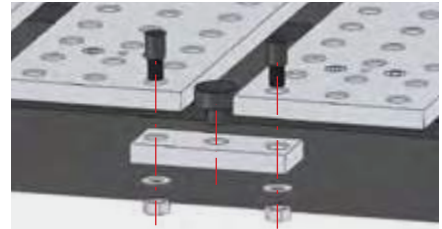

Mount the Channel Block and insert the Rest Button to create a continuous work surface over the table slot.

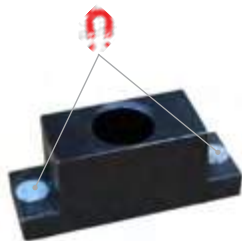

T50940
One Ø5/8 hole



T50950
Two Ø5/8 holes

T-SLOT ADAPTERS *

Slide the T-Slot Adapter into any table slot to create a Ø5/8 table hole along the table slots as needed in fixturing. (Tapped hole is consistent with table hole depth and diameter.)

Locate and mount any fixturing element [Right Angle Brackets, Riser Blocks, Econo Stop & Clamping Squares] directly over table slots.

Part No.	Weight (lb)
T50940	0.4
T50950	1.3

* Not applicable to BuildPro® MAX table.



NEW ITEM

ADJUSTABLE RESTS

Developed by customer demand, the Adjustable Rest is operated manually, by hand adjustment, with a turn of the easy-grip knurled band for complete control in precise, minute height adjustment. (Part No. T54213: Range: 2" – 2-3/4". Part No. T54212: 7/8" height with 5/16" stroke range.)

Insert into any fixturing hole on the BuildPro® Modular Welding Table for use as a support or rest for aligning stock at a uniform height and providing welding clearance. BuildPro® V-Blocks fit into the top cavity of the Adjustable Rests to support round pipes. Adjustable Rests are stackable for use with tall stock.

Three mounting options (**Part No.:T54213**):

- Insert into any hole on the BuildPro table with the Ø5/8" Locating Post.
- Securely fasten to the tabletop for repetitive applications using the Locking Pin with cap screw (included).
- Remove the Locating Post or the Locking Pin, and place the Rest anywhere on the BuildPro tabletop.



T54213

Two Interchangeable Locating Posts



T54212

Low Profile
Fixed Ø5/8" Locating Post ONLY

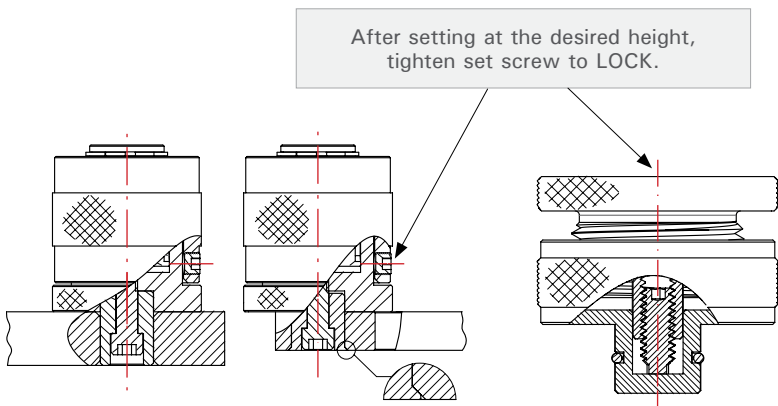

Part No.	Top Dia. (in)	Locating Post Dia. (in)	Range (in)	Weight (lb)
T54213	1.75	5/8	2 ~ 2-3/4	1.13
T54212	1.75	5/8	7/8 ~ 1-3/16	0.54

Find the product video on:
youtu.be/MGRzXSbWQNY



FIXED REST

Developed by customer demand, the Fixed Rest features 5/8" bored hole to hold V-Blocks and V-Block Spacers. Insert into any fixturing hole on the BuildPro® Table for use as a support or rest for aligning stock.

Three mounting options:

- Insert into any hole on the BuildPro table with the Ø5/8" Locating Post.
- Securely fasten to the tabletop for repetitive applications using the Locking Pin with cap screw (included).
- Remove the Locating Post or the Locking Pin, and place the Rest anywhere on the BuildPro tabletop.



Part No.	Ø A (in)	B (in)	Ø C (in)	Weight (lb)
T54214	1.6	2	0.625	0.7



MAGNETIC REST BUTTONS

Magnets on the bottom of the Magnetic Rest Buttons allow the button to be used at ANY point on the tabletop to elevate workpieces. Stack Magnetic Rest Buttons to elevate workpieces in 0.45", 0.625", and 1" increments.



Part No.	Dimension Ø x H (in)	Weight (lb)
T50737	1.5 x 0.45	0.2
T51740	1.5 x 0.625	0.4
T51745	1.5 x 1	0.6

REST BUTTON

T54200 serves as a part rest to elevate parts above the table top.



Part No.	Ø A (in)	B (in)	Ø C (in)	Weight (lb)
T54200	1.6	0.6	0.625	0.4



V-BLOCKS

V-Blocks are designed to hold round parts. They fit into the holes of the: BuildPro® Table, Riser Blocks and Right Angle Brackets.

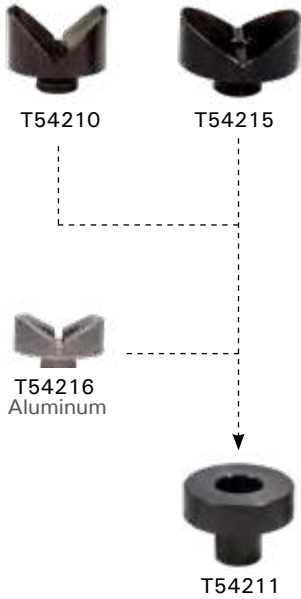

Part No.	Angle	Dimension (in)	Max. Tube Size (in)	Weight (lb)
T54210	90°	Ø1.6 x 1.3	2	0.3
T54215	120°	Ø1.6 x 1.1	2.5	0.3
T54216	120°	Ø1.6 x 0.9	2.5	0.1

V-BLOCK SPACER

Use the V-Block Spacer T54211 to elevate V-Blocks 0.47" for height uniformity when fixturing with the Straight Edge Stops.

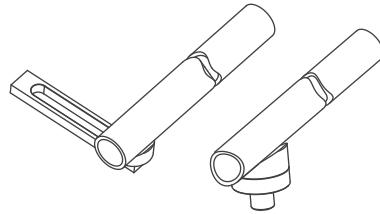
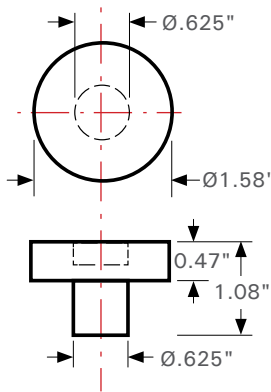

Mount V-Blocks on V-Block Spacers to equal the height of V-Blocks mounted on Straight Edge Stops.

Part No.	Weight (lb)
T54211	0.2



HEAVY DUTY V-BLOCKS

Developed by customer demand, these Heavy Duty V-Blocks hold round stock from 3" – 8" in diameter at 120° - 150°.



Part No.	Angle	Dimension (in)	Max. Tube Size (in)	Weight (lb)
T54310	120°	Ø 2.4 x 1.7	3"	1.2
T54315	150°	Ø 3.2 x 1.4	8"	1.5

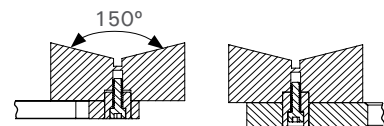
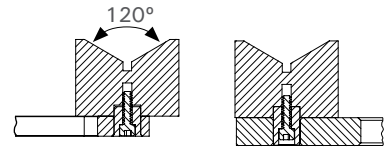

NEW ITEM

BEND RESTS

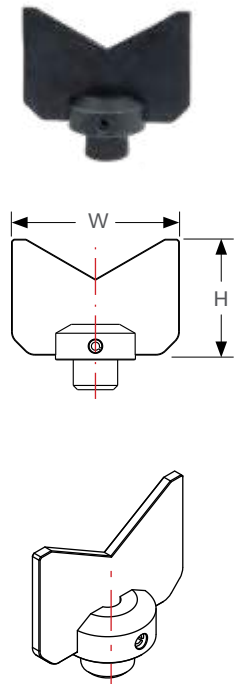

The Bend Rest supports round stock at bends and elbows in fixturing, preventing lateral movement and providing clamp support.

The low profile design allows use of multiple Bend Rests as needed to elevate stock, leaving ample space for clamping.

Place Bend Rests directly into any hole on the BuildPro® Tabletop, or use in combination with BuildPro® Rests to set at desired height to meet clearance or alignment requirements for each unique fixture:

Use with:



ADJUSTABLE RESTS
T54213, T54212
(pg. 38)



FIXED REST
T54214
(pg. 39)

or



V-BLOCK SPACER
T54211
(pg. 40)



Part No.	Angle	W x H (in)	Max. Tube Size (in)	Weight (lb)
T54320	120°	1.6 x 1.6	2.5	0.3
T54325	120°	2.4 x 1.7	3	0.3
T54330	150°	3.2 x 1.4	8	0.3

SETUP CONE

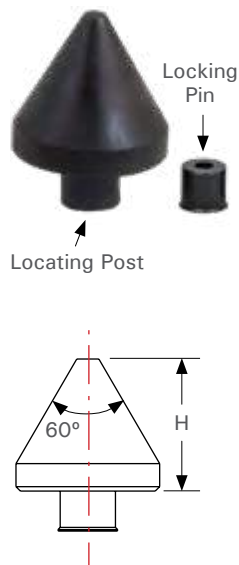

Use the Setup Cone to locate and position round tubing horizontally or vertically through the centerline. The Setup Cone locates from within the tube ID [max. 1-1/2"] at the tube ends, allowing for centerline location and positioning. Mount the Setup Cones on BuildPro® Accessories using either of two interchangeable bases provided:

HORIZONTAL clamping: Securely fasten to any 5/8" mounting hole on clamping accessories using the Locking Pin with cap screw.

VERTICAL clamping: Insert into any 5/8" mounting hole on clamping accessories or the tabletop, using the Locating Post.

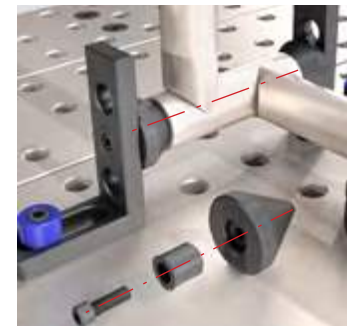

Horizontal application using Locking Pin



Vertical application using Locating Post + V-Block Spacer

Part No.	Angle	Dia. x H (in)	ID Pipe Range (in)	Weight (lb)
T54220	60°	1.625 x 1.5	.25 < x < 1.625	0.5

NEW ITEM

NEW ITEM

MAGNETIC PLUGS / REST BUTTONS



Set of four 1" Magnetic Plug / Rest Button can be used on any flat surface, inserted into the holes on the BuildPro® Table or the holes on BuildPro® Economy Clamping Squares.

Part No.	Ø A (in)	Ø B (in)	C (in)	D (in)	Weight (lb)
T55410-K4	5/8	1	0.45	1	0.2

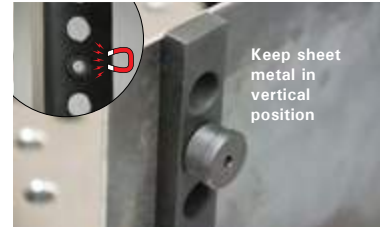

SLIDING CHANNEL BASES *



T51300



T51305

Mount work-holding devices onto these Sliding Channel Bases.

Slide into the 1.7" slots between the plates.

Part No.	Description	Weight (lb)
T51300	Non-rotatable and without holes for user customization.	1.5
T51305	Rotatable with 1/2-13 threaded hole on one side, 3/8-16 on the other side.	1.4



* Not applicable to BuildPro® MAX table.

ECCENTRIC PADS



T54410



T54415

Using the "CAM" design principle, the eccentric pad provides a quick way to position the edge of the workpiece to a locating stop. The 360° rotation allows infinite adjustments.

Ideal for locating round and odd shape parts where conventional edge stops cannot reach.

* Eccentric Pads are 1/2" thick.

[Use Ball Lock Bolts, pg. 44 not included, to mount the Eccentric Pads]

Part No.	Adjust Range (in)	Offset (in)	Thread	Weight (lb)
T54410	0.55 - 0.95	0.2	--	0.2
T54415	0.6 - 2	0.7	5/16-18	0.5

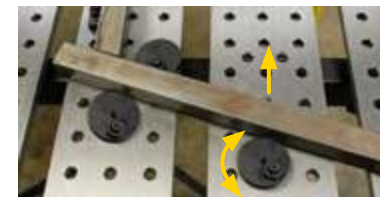

NEW ITEM



STOPS

T54203 and T54205 are used as a stop wherever parts need to be positively located for clamping.

Part No.	Ø A (in)	B (in)	Ø C (in)	Weight (lb)
T54203	1	1.5	0.625	0.4
T54205	1	2	0.625	0.5



THREADED ADAPTERS - UNIQUE

Convert any hole in the table into a threaded hole. Place the Adapter in position beneath the tabletop, in alignment with table holes. Magnets hold threaded adapter in place.



For 2 Threaded Holes with one magnet

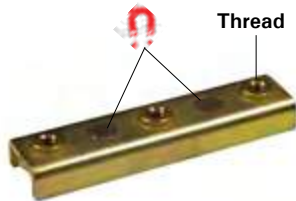

For 3 Threaded Holes with two magnets

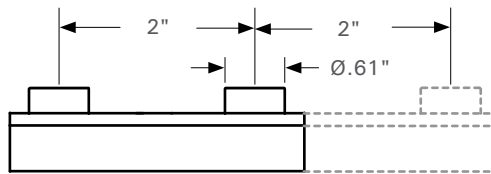
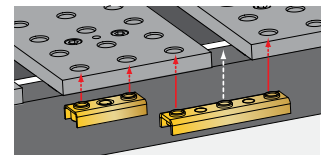

TXT52 Series

(TXT53 Series)

Part No.	Number of Holes	Threaded Holes	Magnets	Weight (lb)
TXT5203	2	5/16-18	1	0.3
TXT5204		3/8-16		0.3
TXT5205		1/2-13		0.3
TXT5303	3	5/16-18	2	0.6
TXT5304		3/8-16		0.6
TXT5305		1/2-13		0.6

BALL LOCK BOLTS - An essential component in Modular Fixturing!

Ball Lock Bolts are a time-saving, efficient method of locating, and fastening fixture elements to the BuildPro® tabletop.

Insert the Ball Lock Bolt over the fixturing element and turn the knurled head with your hand for initial positioning. The Ball Lock Bolt consists of three locking steel balls in the bolt shank that move outward to lock against the bottom chamfer of the table plate, pulling the fixture components securely downward and tightening them in place. Once all the Bolts are positioned, tighten the socket head cap screw top of the Bolts with a hex wrench. Ball Lock Bolts release quickly from the Bolt top with a turn of your hex wrench.

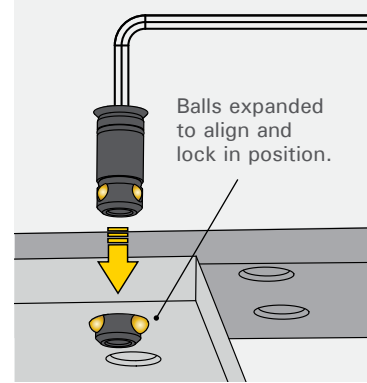

Fixed Length
T55010

Hex Wrench: 1/4"



Fixed Length
T55015

Hex Wrench: 1/4"



Flush-Mount
T55020 | T55025

Hex Wrench: 5/32"



Adjustable
T55055

Hex Wrench: 1/4"

Part No.	Type	Description	Weight (lb)
T55010	Fixed	For connecting 2 accessories together, 0.94" capacity.	0.2
T55015		For connecting an accessory to the tabletop, 1.1" capacity.	0.2
T55020	Flush	For connecting 2 accessories together, 0.94" capacity.	0.1
T55025		For connecting an accessory to the tabletop, 1.1" capacity.	0.1
T55055	Adjustable	Adjustable range: 0.88" ~ 1.08", Connecting tables to accessories, and accessories to accessories.	0.14
TMS5101	--	4 Steel Balls and 6 O-Rings	0.02



Bulk Packages

Part No.	Description	Weight (lb)
T55011	10 pc. of T55010	2
T55016	10 pc. of T55015	2
T55021	10 pc. of T55020	1
T55026	10 pc. of T55025	1
T55056	10 pc. of T55055	1.5

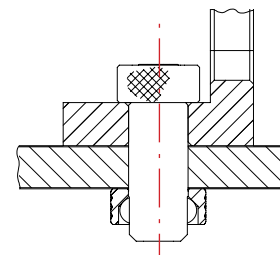

* Use with Ball End Hex Wrench Set featured on pg. 51.



Receiver Bushing
T55804

RECEIVER BUSHING - for Ball Lock Bolts

Use the Receiver Bushing with Ball Lock Bolts [Adjustable model and T55015] when mounting two fixturing elements together slot-to-slot.

Part No.	Weight (lb)
T55804	0.03

NEW ITEM

LOCATING PIN



Locating Pins provide an economic alternative to using multiple Ball Lock Bolts. Use Locating Pins in combination with Ball Lock Bolts to fasten fixturing elements, such as Straight Edge Stops, to the BuildPro Tabletop. Locating Pins aid in holding fixturing elements in position.



(A minimum of one Ball Lock Bolt must be used along with the Locating Pin to secure accessories to the tabletop. The Locating Pin cannot be used as an independent fastening element.)

Part No.	Ø A (in)	B (in)	Ø C (in)	Weight (lb)
T54201	0.9	0.5	0.625	0.2

SOCKET SHOULDER SCREWS SET

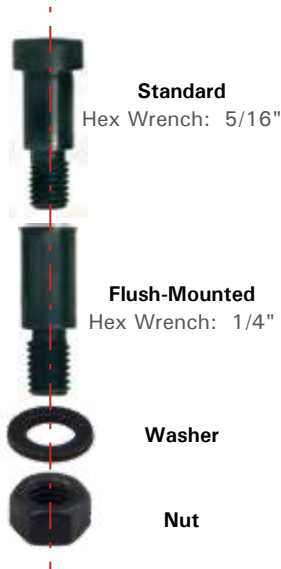

These precision shoulder screws fit into the table holes and can hold and position BuildPro® accessories and other components.

Provided with a nut and washer. Choose from standard and flush-mounted versions.

Part No.	Type	T (in)	Weight (lb)
T831605	Standard	1/2	0.1
T831607		3/4	0.2
T831608		7/8	0.2
T831610		1	0.2
T831612		1-1/4	0.2
T832607	Flush	3/4	0.1
T832608		7/8	0.1
T832610		1	0.1
T832612		1-1/4	0.2

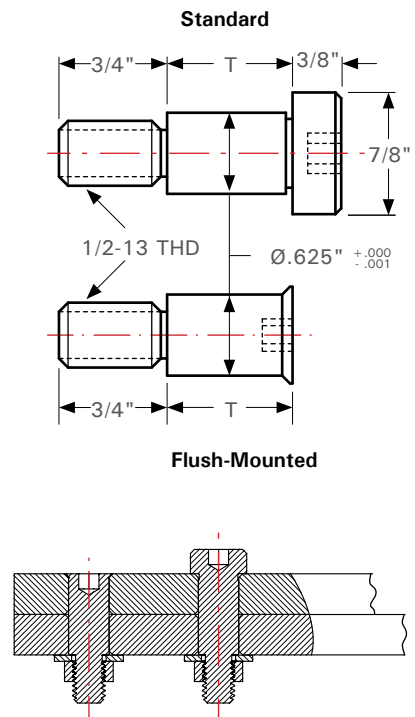

** Use with Ball End Hex Wrench Set featured at pg. 51.*

3 PC. BALL END HEX WRENCH SET



TMXW-K

Use with Ball Lock Bolts & Socket Shoulder Screws.

**Also available individually:*

- TMXW1562 - 5/32" Wrench
- TMXW2500 - 1/4" Wrench
- TMXW3125 - 5/16" Wrench



NEW ITEM



The NEW BuildPro® Tool Cart will help you inventory and organize your BuildPro Clamps and Components, and keep them within arm's reach for faster fixture setup, and tear down.

Dedicated placement for each clamp and component makes the cart easy to setup and maintain. Smart design features allow for quick, convenient "park and pickup" of the Clamps and Components.

Use the Cart to hold any of the BuildPro Fixturing Kits, Part Nos. TMK510 – TMK550. The Cart is constructed from 2" x 1" tubing with a rust resistant powder coated black finish.

Two fixed casters and two swiveling casters with foot pedal safety lock provide easy maneuverability.

Part No.	Dimension W x D x H (in)	Capacity (lb)	Gross Weight (lb)
TMC8080	31 x 20 x 43	220	87

"FULLY OPEN" DESIGN FOR VISIBILITY AND QUICK ACCESS.

Safety pegs have rounded ends, and keep Straight Edge Stops ready to grab and use.

"Bridge" channel is the ideal width to hold Ball Lock Bolts, an essential component in fixturing.

Two fixed casters and two swiveling casters with foot pedal safety lock provide easy maneuverability.



Dedicated placement for each clamp and component.

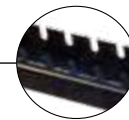

Rear Slotted Cross Bar on back holds clamps and pliers.

Magnetic bar steadies Right Angle Brackets.

The bottom shelf holds bulky items such as HD Riser Blocks. The 1-1/4" lip around the bottom shelf prevents items from falling while moving.

(Fixturing Kit sold separately.)



128 - PIECE SQUARE TUBE KIT

Part No. TMK535 | Gross Weight: 163 lb

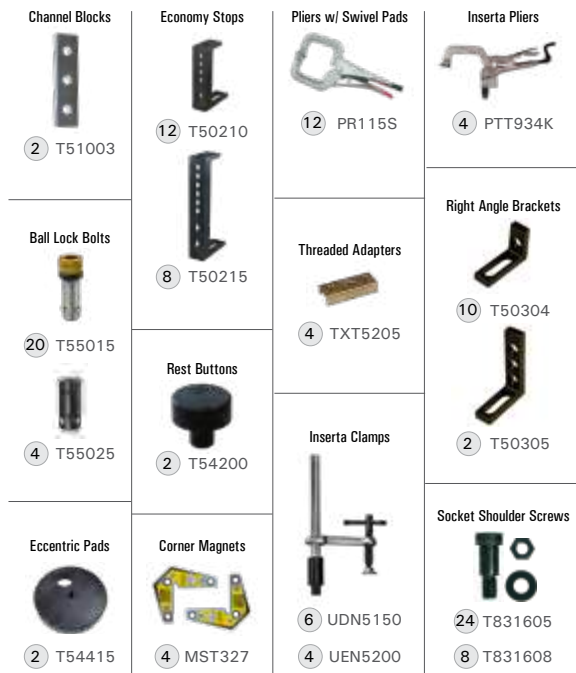

* FREE Ball End Hex Wrench Set with TMK535 purchase. See pg. 51.

128 - PIECE KIT

Qty.	Description
2	Channel Blocks (T51003)
24	Ball Lock Bolts (20 x T55015, 4 x T55025)
2	Eccentric Pads (T54415)
20	Economy Stops (12 x T50210, 8 x T50215)
2	Rest Buttons (T54200)
4	Corner Magnets (MST327)
12	Pliers 11" w/ Swivel Pads (PR115S)
4	Threaded Adapters (TXT5205)
10	Inserta Clamps (6 x UDN5150, 4 x UEN5200)
4	Inserta Pliers (PTT934K)
12	Right Angle Brackets (10 x T50304, 2 x T50305)
32	Socket Shoulder Screws (24 x T831605, 8 x T831608)

BASIC FRAMING KIT

166 - PIECE ROUND TUBE KIT

Part No. TMK537 | Gross Weight: 136 lb

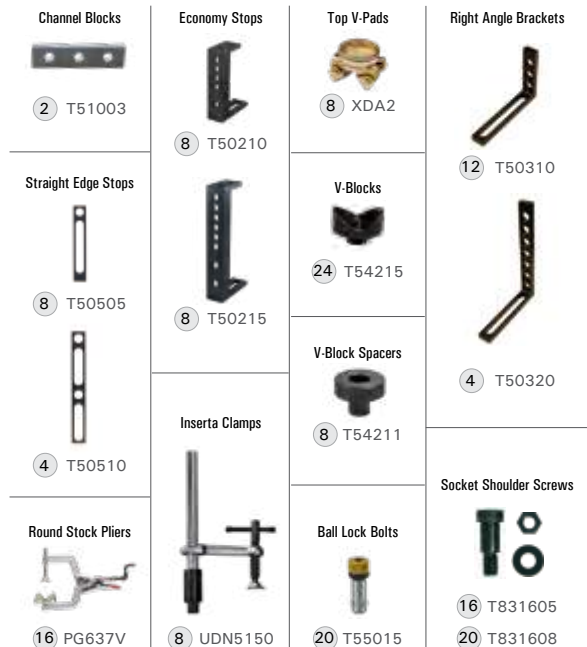

* FREE Ball End Hex Wrench Set with TMK537 purchase. See pg. 51.

166 - PIECE KIT

Qty.	Description
2	Channel Blocks (T51003)
12	Straight Edge Stops (8 x T50505, 4 x T50510)
16	Round Stock Pliers (PG637V)
16	Economy Stops (8 x T50210, T50215)
8	Inserta Clamps (UDN5150)
8	Top V-Pads (XDA2)
24	V-Blocks (T54215)
8	V-Block Spacers (T54211)
20	Ball Lock Bolts, Fixed (T55015)
16	Right Angle Brackets (12 x T50310, 4 x T50320)
36	Socket Shoulder Screws (16 x T831605, 20 x T831608)

10 - PIECE KIT

Qty.	Description
2	Riser Blocks (T50115)
8	Socket Shoulder Screws (T832610)

TABLE JOINING KIT

10 - PIECE KIT

Part No. TMK505 | Gross Weight: 11 lb

Riser Blocks



Socket Shoulder Screws



38 - PIECE KIT

Qty.	Description
12	Ball Lock Bolts (4 x T55010, 8 x T55015)
4	Magnetic Rest Buttons (T50737)
4	Inserta Clamps (UDN5150)
4	Stops (T54205)
2	Right Angle Brackets (T50305)
2	Threaded Adapters (TXT5204, TXT5205)
10	Straight Edge Stops (6 x T50505, 4 x T50510)

38 - PIECE KIT

Part No. TMK510 | Gross Weight: 19 lb



80 - PIECE KIT

Qty.	Description
20	Ball Lock Bolts, Fixed (10 x T55010, T55015)
4	Ball Lock Bolts, Adjustable (T55050)
4	V-Blocks (2 x T54210, T54215)
4	Stops (T54205)
8	Inserta Clamps (4 x UDN5150, 2 x UEN5200, UERN5200)
12	Straight Edge Stops (4 x T50505, T50510, T50517)
4	Threaded Adapters (2 x TXT5204, TXT5205)
4	Top V-Pads (2 x XDA2, XFA2)
4	Eccentric Pads (2 x T54410, T54415)
12	Right Angle Brackets (4 x T50304, T50305, T50310)
4	Magnetic Rest Button (T50737)





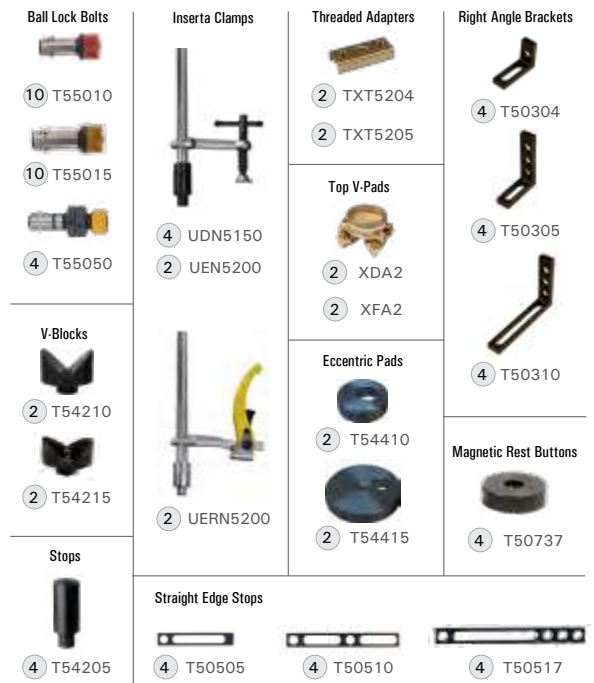



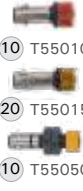
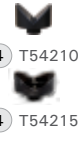
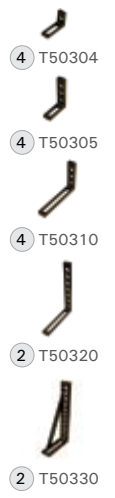

80 - PIECE KIT

Part No. TMK520 | Gross Weight: 45 lb

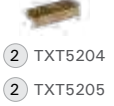

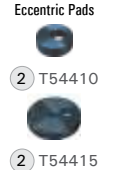
120 - PIECE KIT







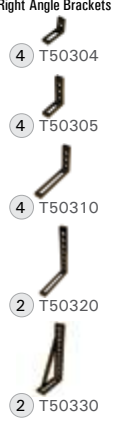
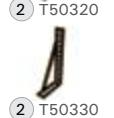

Part No. TMK530 | Gross Weight: 88 lb

Ball Lock Bolts  10 T55010 20 T55015 10 T55050	V-Blocks  4 T54210 4 T54215	Right Angle Brackets  4 T50304 4 T50305 4 T50310 2 T50320 2 T50330	Inserta Pliers  2 PTT634K 2 PTT934K
Mag. Rest Buttons  4 T50737	Inserta Clamps  4 UDN5150 4 UEN5200	MagSpring Clamps  2 UDV45	Threaded Adapters  2 TXT5204 2 TXT5205
Stops  4 T54205	Economy Stops  2 T50205 2 T50210	Eccentric Pads  2 T54410 2 T54415	Top V-Pads  2 XDA2 2 XFA2
Straight Edge Stops  4 T50505 4 T50510 4 T50517	Magnetic V-Pads  2 XDV4 2 XFV4		

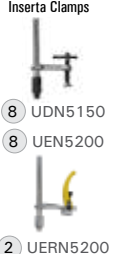
* FREE Ball End Hex Wrench Set with TMK530 purchase. See pg. 51.

146 - PIECE KIT

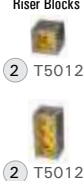
Part No. TMK540 | Gross Weight: 157 lb

Ball Lock Bolts  10 T55010 20 T55015 10 T55050	Straight Edge Stops  4 T50505 4 T50510 4 T50517	V-Blocks  4 T54210 4 T54215	Right Angle Brackets  4 T50304 4 T50305 4 T50310 2 T50320 2 T50330
Eccentric Pads  2 T54410 2 T54415	Inserta Pliers  2 PTT956K	Top V-Pads  4 XDA2 4 XFA2	Magnetic V-Pads  2 XDV4 2 XFV4
Mag. Rest Buttons  4 T50737	MagSpring Clamps  2 UDV45	Inserta Clamps  8 UDN5150 8 UEN5200	Economy Stops  2 T50205 2 T50210 2 T50215
Connectors  2 T54605	Round Stock Pliers  2 PG637V	Threaded Adapters  4 TXT5204 4 TXT5205	Magnetic Rests  2 T55410
Riser Blocks  2 T50120 2 T50125	Stops  4 T54205		

* FREE Ball End Hex Wrench Set with TMK540 purchase. See pg. 51.

120 - PIECE KIT

Qty.	Description
30	Ball Lock Bolts, Fixed (10 x T55010, 20 x T55015)
10	Ball Lock Bolts, Adjustable (T55050)
4	Magnetic Rest Buttons (4 x T50737)
4	Stops (4 x T54205)
12	Straight Edge Stops (4 x T50505, T50510, T50517)
8	V-Blocks (4 x T54210, T54215)
10	Inserta Clamps (4 x UDN5150, UEN5200, 2 x UERN5200)
4	Economy Stops (2 x T50205, T50210)
16	Right Angle Brackets (4 x T50304, T50305, T50310, 2 x T50320, T50330)
4	Eccentric Pads (2 x T54410, T54415)
4	Inserta Pliers (2 x PTT634K, PTT934K)
2	MagSpring Clamps (2 x UDV45)
4	Threaded Adapters (2 x TXT5204, TXT5205)
4	Top V-Pads (2 x XDA2, XFA2)
4	Magnetic V-Pads (2 x XDV4, XFV4)



146 - PIECE KIT

































Qty.	Description
30	Ball Lock Bolts, Fixed (10 x T55010, 20 x T55015)
10	Ball Lock Bolts, Adjustable (T55050)
4	Eccentric Pads (2 x T54410, T54415)
4	Magnetic Rest Button (T50737)
2	Connectors (T54605)
4	Riser Blocks (2 x T50120, T50125)
12	Straight Edge Stops (4 x T50505, T50510, T50517)
2	Inserta Pliers (PTT956K)
2	MagSpring Clamps (UDV45)
2	Round Stock Pliers (PG637V)
8	Threaded Adapters (4 x TXT5204, TXT5205)
2	Magnetic Rests (T55410)
8	V-Blocks (4 x T54210, T54215)
8	Top V-Pads (4 x XDA2, XFA2)
4	Magnetic V-Pads (2 x XDV4, XFV4)
18	Inserta Clamps (8 x UDN5150, UEN5200, 2 x UERN5200)
4	Stops (T54205)
16	Right Angle Brackets (4 x T50304, T50305, T50310, 2 x T50320, T50330)
6	Economy Stops (2 x T50205, T50210, T50215)

172 - PIECE KIT

Qty.	Description
40	Ball Lock Bolts, Fixed (20 x T55010, T55015)
10	Ball Lock Bolts, Adjustable (T55050)
8	Threaded Adapters (4 x TXT5204, TXT5205)
4	Stops (T54205)
8	V-Blocks (4 x T54210, T54215)
4	Magnetic V-Pads (2 x XDV4, XFV4)
6	Riser Blocks (2 x T50120, T50125, T50130)
12	Straight Edge Stops (4 x T50505, T50510, T50517)
4	MagSpring Clamps (2 x UDV45, UDV65)
4	Eccentric Pads (2 x T54410, T54415)
2	Connectors (T54605)
4	Magnetic Rests (T55410)
4	Magnetic Rest Buttons (T50737)
20	Inserta Clamps (8 x UDN5150, UEN5200, 4 x UERN5200)
8	Economy Stops (2 x T50205, T50210, 4 x T50215)
16	Right Angle Brackets (4 x T50304, T50305, T50310, 2 x T50320, T50330)
8	Inserta Pliers (4 x PTT634K, PTT956K)
2	Round Stock Pliers (PG637V)
8	Top V-Pads (4 x XDA2, XFA2)

172 - PIECE KIT

Part No. TMK550 | Gross Weight: 225 lb

Ball Lock Bolts  20 T55010  20 T55015  10 T55050	Straight Edge Stops  4 T50505  4 T50510  4 T50517	Mag. Rest Buttons  4 T50737	Right Angle Brackets  4 T50304  4 T50305  4 T50310  2 T50320  2 T50330
Threaded Adapters  4 TXT5204 4 TXT5205	MagSpring Clamps  2 UDV45 2 UDV65	Inserta Clamps  8 UDN5150 8 UEN5200  4 UERN5200	
Stops  4 T54205	Eccentric Pads  2 T54410  2 T54415	Economy Stops  2 T50205  2 T50210  4 T50215	Inserta Pliers  4 PTT634K 4 PTT956K
V-Blocks  4 T54210  4 T54215	Connectors  2 T54605	Magnetic Rests  4 T55410	Round Stock Pliers  2 PG637V
Magnetic V-Pads  2 XDV4 2 XFV4			
Riser Blocks  2 T50120  2 T50125  2 T50130			Top V-Pads  4 XDA2 4 XFA2

* FREE Ball End Hex Wrench Set with TMK550 purchase. See below.

3 - PIECE KIT

Qty.	Description
1	Ball End Hex Wrench - 5/32" (1 x TMXW1562)
1	Ball End Hex Wrench - 1/4" (1 x TMXW2500)
1	Ball End Hex Wrench - 5/16" (1 x TMXW3125)

BALL END HEX WRENCH SET

3 - PIECE KIT

Part No. TMXW-K | Gross Weight: 1 lb

Free with your purchase of these BuildPro® Fixturing Kits:

TMK530 | TMK535 | TMK537 | TMK540 | TMK550

5/32" Wrench  1 TMXW1562	1/4" Wrench  1 TMXW2500	5/16" Wrench  1 TMXW3125
---	--	---

NEW ITEM

SUGGESTED PARTS LIST:

- Inserta Clamps
- Inserta Pliers
- Econo Stop & Clamping Squares
- Right Angle Brackets
- Rest Buttons
- Channel Blocks
- Ball Lock Bolts
- Socket Shoulder Screws
- Threaded Adapters

Strong Hand Tools Products:

- ◇ Swivel Tip Pliers
- ◇ Corner Magnets
- ◇ Adjust-O Magnets

Find the fixturing video on:
youtu.be/aD6DYVINAv4



EQUIPMENT RACK



SUGGESTED PARTS LIST:

- Universal Flange & Pipe Clamping Plate with Inserta Pliers
- Sliding Channel Clamp
- Chain Pliers with Table Mounting Bases
- Malleable Cast Iron Clamping Squares
- Right Angle Brackets
- Ball Lock Bolts
- Straight Edge Stops
- Heavy Duty V-Blocks
- Adjustable Rests
- Fixed Rests
- T-Slot Adapter

Find the fixturing video on:
youtu.be/dvw1Xj1KfHc



UNIVERSAL FLANGE AND PIPE FIXTURE HOLDS STANDARD ASME / ANSI / DIN FLANGES



STAIR RAIL



SUGGESTED PARTS LIST:

- Inserta Pliers
- Straight Edge Stops
- V-Blocks
- Ball Lock Bolts

Find the fixturing video on:
youtu.be/Yxr2Y10E0_c



OVERSIZED SQUARE TUBE FRAME ON FOUR JOINED TABLES

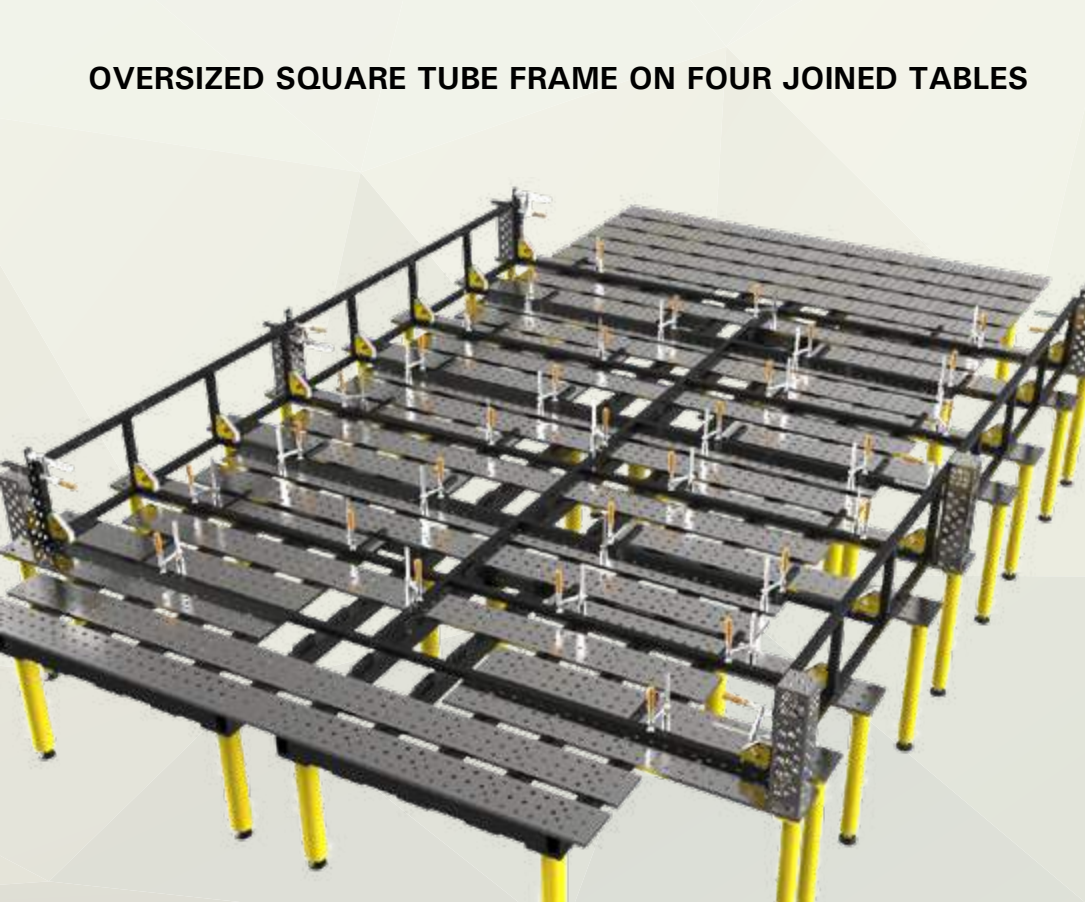

SUGGESTED PARTS LIST:

- Inserta Clamps
- Straight Edge Stops
- Riser Blocks

Strong Hand Tools Products:

- ◇ *Adjust-O Magnets*

SUGGESTED PARTS LIST:

- Round Stock Pliers
- Inserta Pliers
- Toggle Clamps
- Riser Blocks
- Econo Stop & Clamping Squares
- Straight Edge Stops
- Ball Lock Bolts

CART BASE

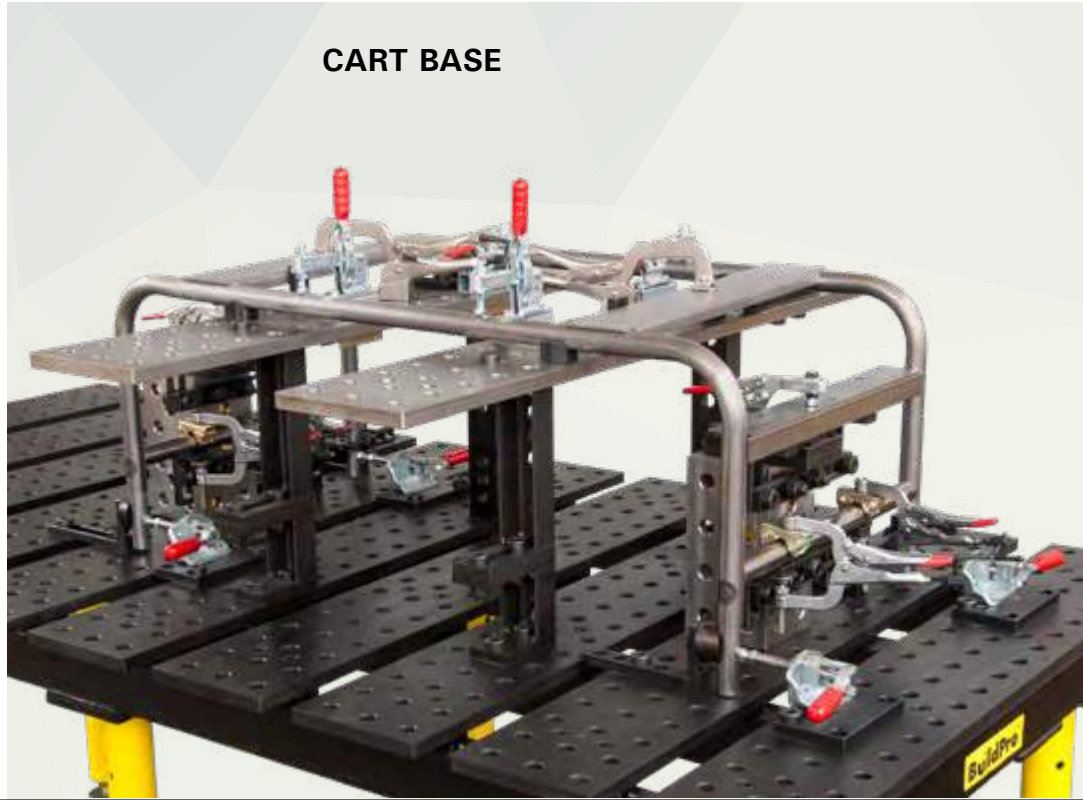

SUGGESTED PARTS LIST:

- Inserta Pliers
- Toggle Clamps
- Inserta Clamps
- Riser Blocks
- Right Angle Brackets
- Straight Edge Stops
- Stops
- Ball Lock Bolts
- Rest Buttons

TABLE BASE

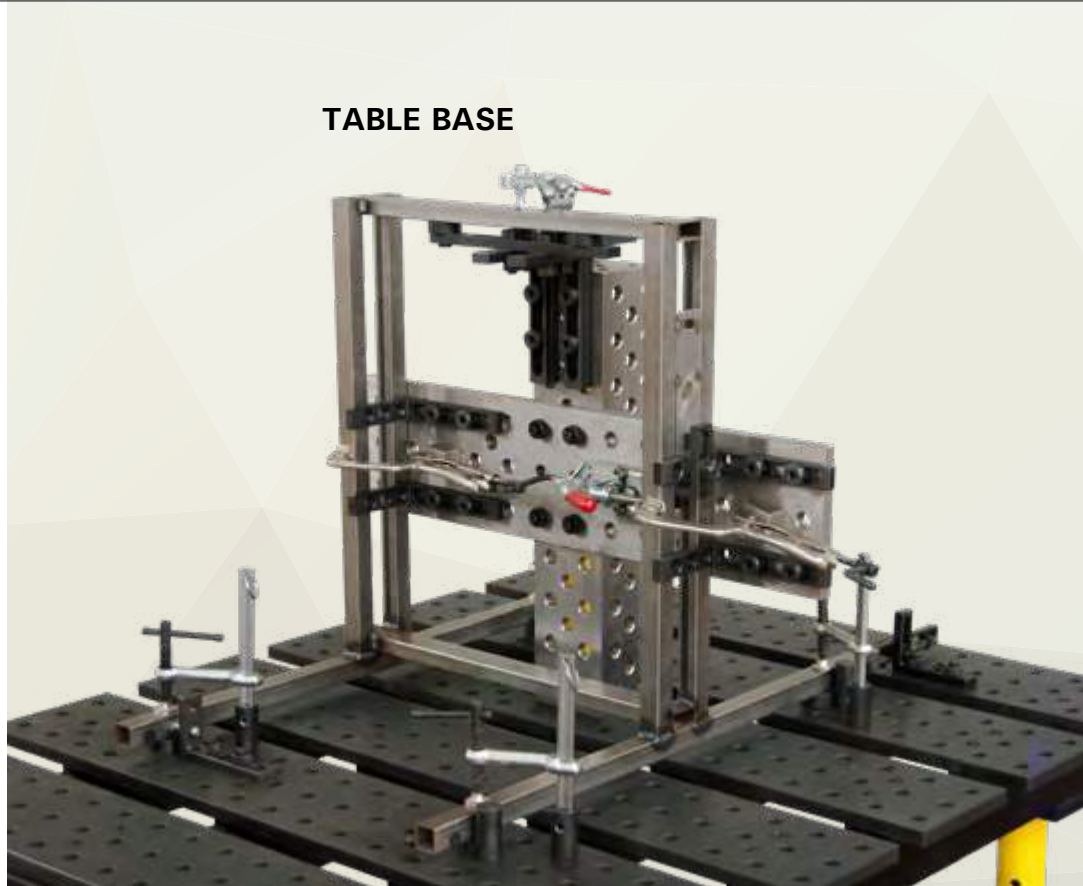

MATERIAL HANDLER



SUGGESTED PARTS LIST:

- Right Angle Brackets
- Ball Lock Bolts
- V-Blocks

Strong Hand Tools Products:

- ◇ Swivel Tip Pliers
- ◇ Pipe Pliers
- ◇ Mini Magnets

AGRICULTURAL EQUIPMENT

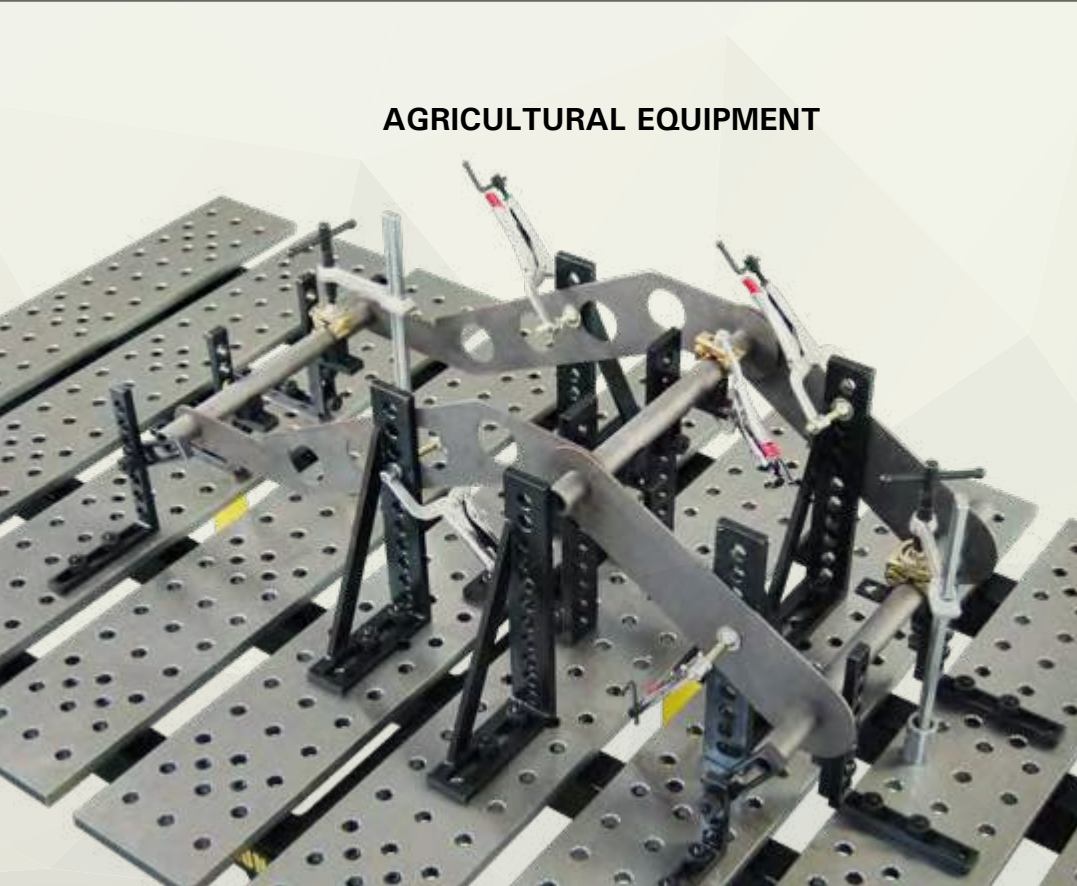

SUGGESTED PARTS LIST:

- Inserta Clamps
- Right Angle Brackets
- Ball Lock Bolts
- Top V-Pads
- Straight Edge Stops

Strong Hand Tools Products:

- ◇ Multi-Purpose Pliers

SUGGESTED PARTS LIST:

- Inserta Clamps
- Right Angle Brackets
- Ball Lock Bolts
- Magnetic Plugs
- Straight Edge Stops

Strong Hand Tools Products:

- ◇ *Joint Master*
- ◇ *Multi-Purpose Pliers*
- ◇ *Mini Magnets*

COOLANT TANK

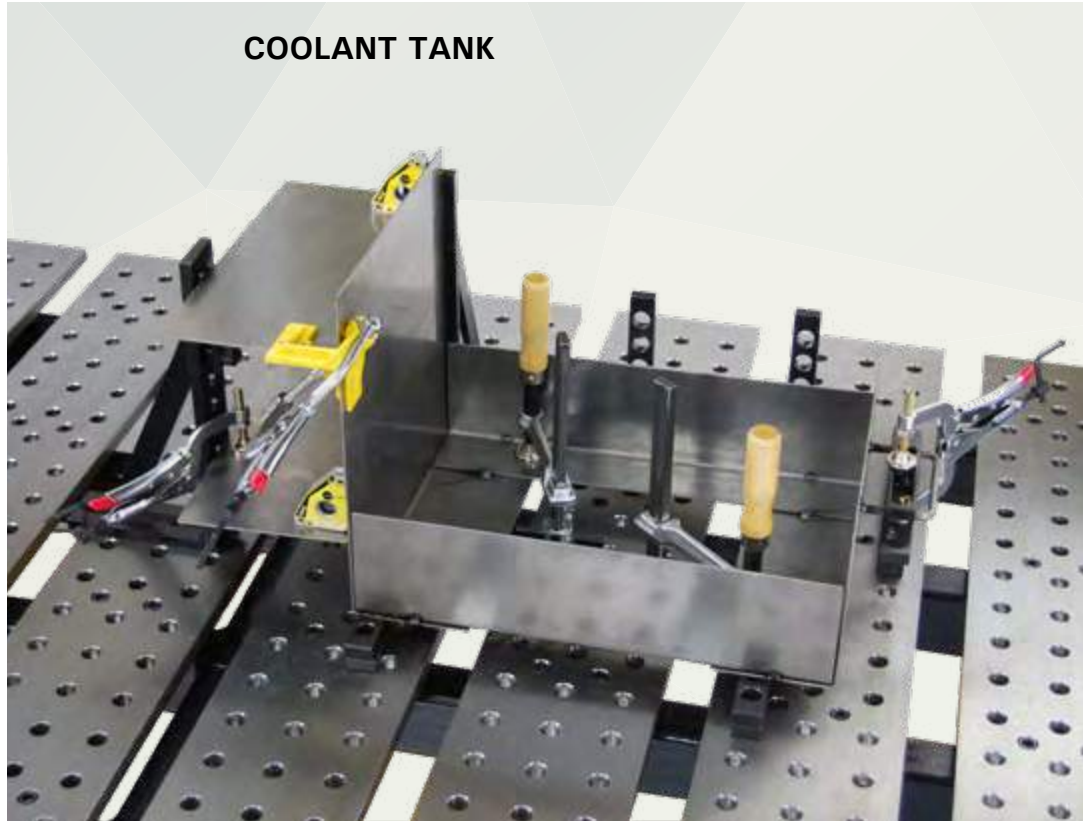

SUGGESTED PARTS LIST:

- Sliding Channel Clamps
- Inserta Clamps
- Right Angle Brackets
- Ball Lock Bolts
- V-Blocks
- Top V-Pads

BICYCLE FRAME

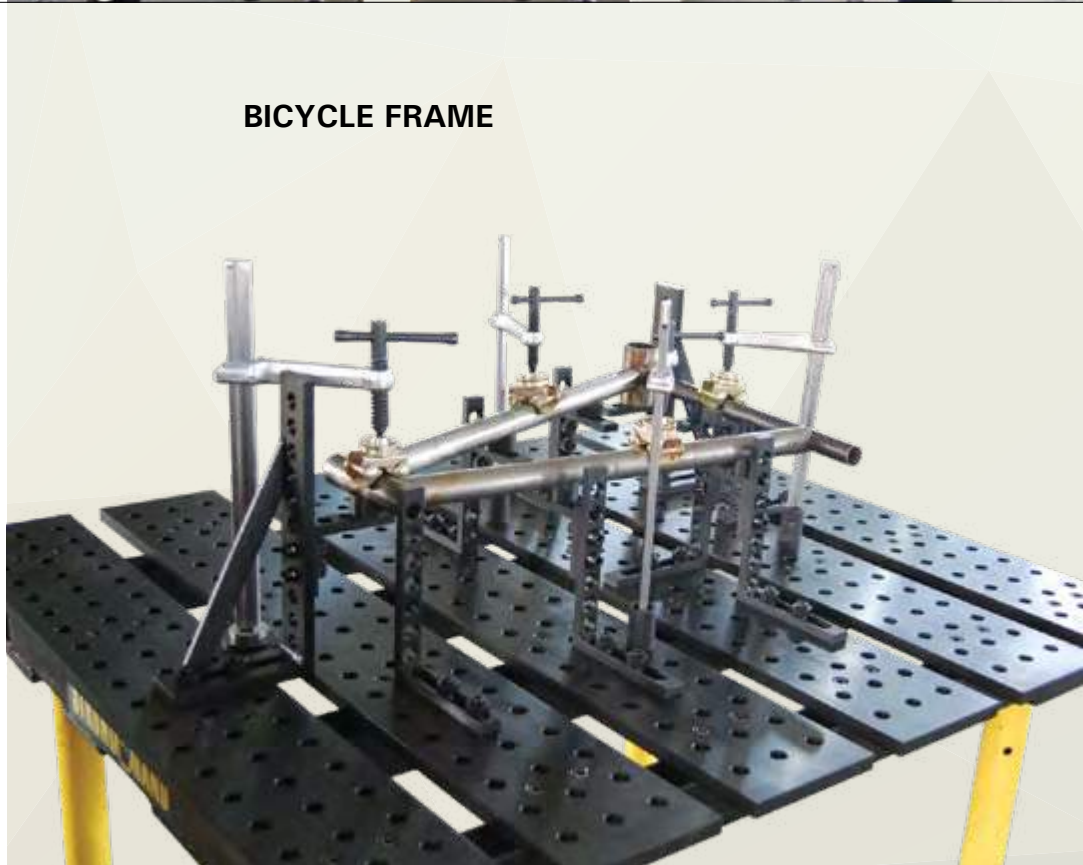

GO-KART FRAME



SUGGESTED PARTS LIST:

- Inserta Pliers
- Inserta Clamps
- Right Angle Brackets
- Ball Lock Bolts
- Econo Stop & Clamping Squares
- V-Blocks
- Top V-Pads
- Straight Edge Stops

Strong Hand Tools Products:

- ◇ *Multi-Purpose Pliers*

Find the fixturing video on:
youtu.be/ODMtHWpbrSQ



NOMAD™ ECONOMY WELDING TABLE - TS SERIES

Very Affordable. Fully Adjustable. Easily Movable.



HOT TIPS: We recommend use of the NOMAD™ Economy Welding Table in combination with use of the BuildPro® Table:

Use the space-saving NOMAD™ Table to tack weld smaller parts that will become part of a larger substructure. Use the NOMAD™ for small, short-run prototypes, reserving the BuildPro® Table for larger, more complex projects.

Use the NOMAD™ as a prep table for those parts that need additional finishing processes before being added to the larger substructure on the BuildPro®. Use the slots in the tabletop to hang the NOMAD™ on workshop hooks for completely out-of-the-way storage.



TOGGLE CLAMPS

Ideal time-saving jig and fixture clamps.
www.goodhandinc.com

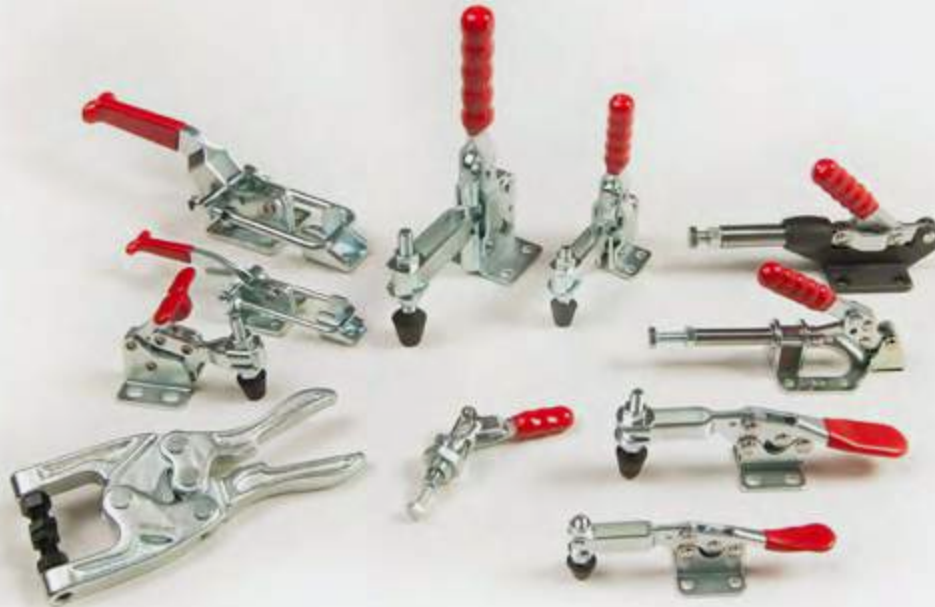

VERTICAL HANDLE

Hold Down Action

PUSH/PULL

Straight Line Action

SIDE MOUNT

F-TYPE

Pull Down Action

YOKE ASSEMBLIES

HORIZONTAL HANDLE

Hold Down Action

LATCH TYPE

Pull Action

TOGGLE PLIERS

Squeeze Action

PNEUMATIC POWER

HEAVY DUTY WELDABLE

Hold Down Action



COMPONENTS

Standard Machine Parts & Tooling Components.
www.valtrainc.com

BEDDING SUPPORTS

FORGED ADJUSTA-CLAMPS

CENTER CAM CLAMPS

HANDWHEELS

CAM ACTION CLAMPS

ADJUSTABLE HANDLES

ROTARY T-SLOT NUTS

CAP SCREW HOOK CLAMPS

HANDKNOBS

LIFTING EYEBOLTS



LEVELING PADS

PINS & LINERS

PLAIN EYEBOLTS

HEAVY DUTY FIXED GLIDES

ROTARY T-SLOT BOLTS

SPRING STOPS

SPEED BALL HANDLES

CRANK HANDLES

T-SLOT BOLTS

T-STRAP BOLTS



STRONG HAND TOOLS®

Welding Clamps · Magnets · Pliers · Vises · Economy Welding Tables

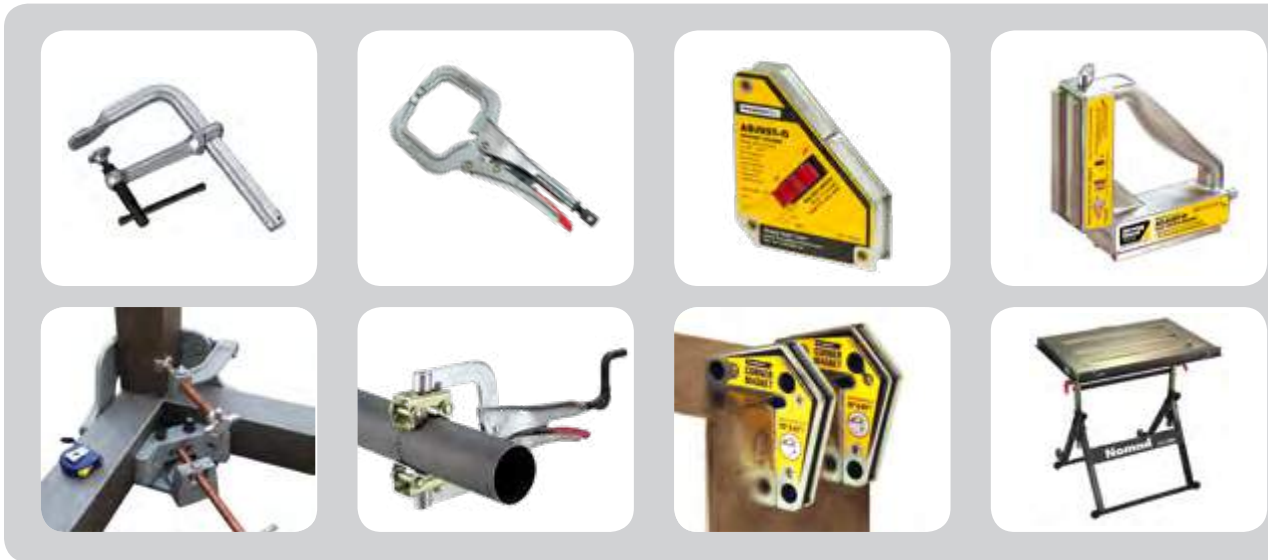

Please call 800.989.5244 to request the full line catalog.

Multi-function, time saving Strong Hand Tools® Clamps, Magnets, and Pliers are Quick Acting, so you save time and money by completing work setups faster.



 **MADE IN GERMANY**

SIEGMUND HEAVY DUTY WELDING TABLES AND CLAMPING SYSTEMS.

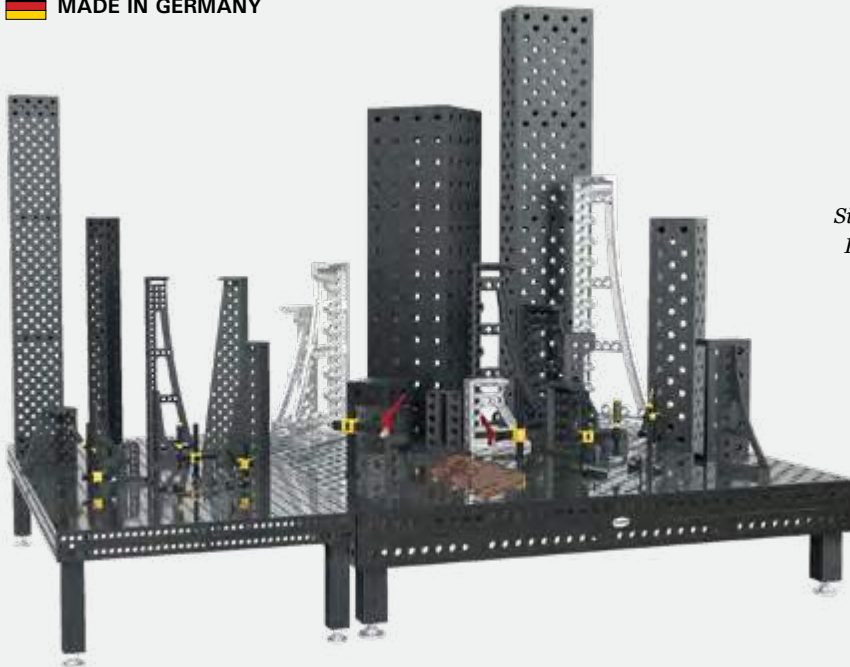

NEW PROFESSIONAL EXTREME 750

Siegmund Welding Tables feature a ONE PIECE, FIVE-FACE design with 25 mm thick reinforced steel plate for an extremely rigid and flat work surface with a load capacity of up to 10 tons.

Constructed from through hardened steel, the Professional Extreme 750 Tables receive a Plasma Nitride Treatment, resulting in a double hardened table that will last a lifetime.

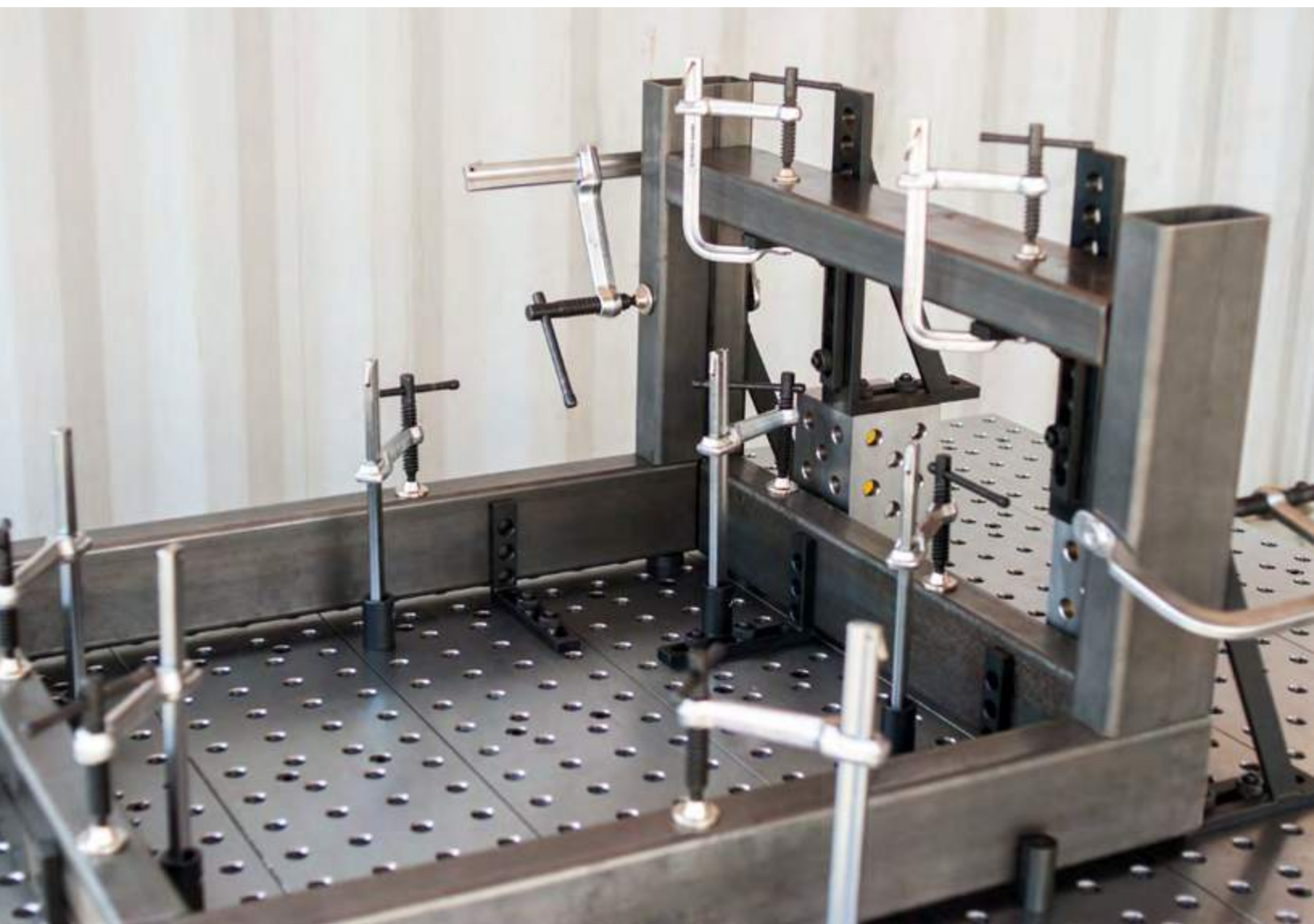

Authorized Distributor

USA Headquarters

8750 Pioneer Blvd, Santa Fe Springs, CA 90670 U.S.A.

Tel: 562-949-8625

Fax: 562-949-4875

sales@stronghandtools.com

Europe

Pražská 410/11 67401 Třebíč, Czech Republic

Tel: +420 607 088 466

Fax: +420 568 853 213

sales@stronghand.eu

Asia

No. 605 Huabo Rd, Huating Town, Jiading District, Shanghai, China 201816

Tel: +86-21-59103639

Fax: +86-21-59102951

asiasales@stronghandtools.com

© 2018 Edition



Find us on
Facebook